

HSC-I Safety anchor

	Anchor version	Benefits
	Internal threaded version:	- the perfect solution for small edge and space distance
	HSC-I carbon steel internal version	- suitable for thin concrete blocks due to low embedment depth
	HSC-IR Stainless steel version ((A4))	- suitable for cracked concrete - self-cutting undercut anchor - internal threaded - stainless steel available for external applications



Concrete



Tensile zone



Shock



Small edge distance and spacing



Fire resistance



Corrosion resistance



European Technical Approval



CE conformity



PROFIS Anchor design software

Approvals / certificates

Description	Authority / Laboratory	No. / date of issue
European technical approval ^{a)}	CSTB, Paris	ETA-02/0027 / 2012-09-20
Shockproof fastenings in civil defence installations	Federal Office for Civil Protection, Bern	BZS D 06-601 / 2006-07-10
Fire test report	IBMB, Braunschweig	UB 3177/1722-1 / 2006-06-28
Assessment report (fire)	warringtonfire	WF 327804/A / 2013-07-10

- All data given in this section according ETA-02/0027 issue 2012-09-20.

Basic loading data

All data in this section applies to

- Correct setting (See setting instruction)
- No edge distance and spacing influence
- Concrete as specified in the table
- *Steel* failure
- Minimum base material thickness
- Concrete C 20/25, $f_{ck,cube} = 25 \text{ N/mm}^2$

For details see Simplified design method

Mean ultimate resistance HSC-I and HSC-IR

Anchor size	Non-cracked concrete					Cracked concrete				
	M6x 40	M8x 40	M10x 50	M10x 60	M12x 60	M6x 40	M8x 40	M10x 50	M10x 60	M12x 60
Tensile $N_{Ru,m}$										
HSC-I [kN]	16,6	16,6	23,3	30,6	30,6	13,3	13,3	18,6	24,5	24,5
HSC-IR [kN]	14,8	16,6	23,3	30,6	30,6	13,3	13,3	18,6	24,5	24,5
Shear $V_{Ru,m}$										
HSC-I [kN]	10,4	15,9	19,8	19,8	23,4	10,4	15,9	19,8	19,8	23,4
HSC-IR [kN]	9,1	13,9	17,3	17,3	20,8	9,1	13,9	17,3	17,3	20,8

Characteristic resistance HSC-I and HSC-IR

Anchor size	Non-cracked concrete					Cracked concrete				
	M6x 40	M8x 40	M10x 50	M10x 60	M12x 60	M6x 40	M8x 40	M10x 50	M10x 60	M12x 60
Tensile N_{Rk}										
HSC-I [kN]	12,8	12,8	17,8	23,4	23,4	9,1	9,1	12,7	16,7	16,7
HSC-IR [kN]	12,8	12,8	17,8	23,4	23,4	9,1	9,1	12,7	16,7	16,7
Shear V_{Rk}										
HSC-I [kN]	8,0	12,2	15,2	15,2	18,2	8,0	12,2	15,2	15,2	18,2
HSC-IR [kN]	7,0	10,7	13,3	13,3	16,0	7,0	10,7	13,3	13,3	16,0

Design resistance HSC-I and HSC-IR

Anchor size	Non-cracked concrete					Cracked concrete				
	M6x 40	M8x 40	M10x 50	M10x 60	M12x 60	M6x 40	M8x 40	M10x 50	M10x 60	M12x 60
Tensile N_{Rd}										
HSC-I [kN]	8,5	8,5	11,9	15,6	15,6	6,1	6,1	8,5	11,2	11,2
HSC-IR [kN]	7,5	8,5	11,9	14,2	15,6	6,1	6,1	8,5	11,2	11,2
Shear V_{Rd}										
HSC-I [kN]	6,4	9,8	12,2	12,2	14,6	6,4	9,8	12,2	12,2	14,6
HSC-IR [kN]	4,5	6,9	8,5	8,5	10,3	4,5	6,9	8,5	8,5	10,3

Recommended loads HSC-I and HSC-IR

Anchor size	Non-cracked concrete					Cracked concrete				
	M6x 40	M8x 40	M10x 50	M10x 60	M12x 60	M6x 40	M8x 40	M10x 50	M10x 60	M12x 60
Tensile N_{rec}^a										
HSC-I [kN]	6,1	6,1	8,5	11,2	11,2	4,3	4,3	6,1	8,0	8,0
HSC-IR [kN]	5,4	6,1	8,5	10,1	11,2	4,3	4,3	6,1	8,0	8,0
Shear V_{rec}^a										
HSC-I [kN]	4,6	7,0	8,7	8,7	10,4	4,6	7,0	8,7	8,7	10,4
HSC-IR [kN]	3,2	4,9	6,1	6,1	7,3	3,2	4,9	6,1	6,1	7,3

- With overall partial safety factor for action $\gamma = 1,4$. The partial safety factors for action depend on the type of loading and shall be taken from national regulations.

Materials

Mechanical properties

Anchor size	HSC	M6x40	M8x40	M10x50	M10x60	M12x60
Nominal tensile strength f_{uk} [N/mm ²]	-I	800	800	800	800	800
	-IR	600	600	700	700	700
Yield strength f_{yk} [N/mm ²]	-I	640	640	640	640	640
	-IR	355	355	350	350	340
Stressed cross-section for internal threaded version $A_{s,I}$ [mm ²]	-I,IR	22,0	28,3	34,6	34,6	40,8
Stressed cross-section for bolt version $A_{s,A}$ [mm ²]	-I,IR	20,1	36,6	58,0	58,0	84,3
Moment of resistance W [mm ³]	-I,IR	12,7	31,2	62,3	62,3	109,2
Design bending resistance without sleeve $M_{Rd,s}$ [Nm]	-I	9,6	24	48	48	84
	-IR	7,1	16,7	33,3	33,3	59,0

Material quality

Part	Material	
Carbon steel		
HSC-I	Cone bolt with , with internal or external thread	steel strength 8.8, galvanised to min. 5 µm
	Expansion sleeve and washer	Galvanised steel
	Hexagon nut	Strength 8
Stainless steel		
HSC-IR	Cone bolt with , with internal or external thread	steel grade 1.4401, 1.4571 A4-70
	Expansion sleeve and washer	steel grade 1.4401, 1.4571
	Hexagon nut	steel grade 1.4401, 1.4571 A4-70

Anchor dimensions

Dimensions of HSC-I and HSC-IR

Anchor version	Thread size	b [mm]	l _s [mm]	d [mm]	l _b [mm]
HSC-I(R) M6x40	M6	13,5	40,8	13,5	43,3
HSC-I(R) M8x40	M8	15,5	40,8	15,5	43,8
HSC-I(R) M10x50	M10	17,5	50,8	17,5	54,8
HSC-I(R) M10x60	M10	17,5	60,8	17,5	64,8
HSC-I(R) M12x60	M12	19,5	60,8	19,5	64,8

marking HILTI 8.8 (or A4)

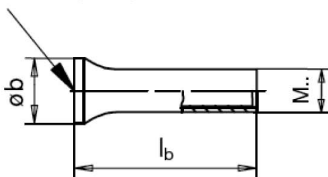

marking e.g. HSC-I M6 x 40 (or HSC-IR M6 x 40 A4)

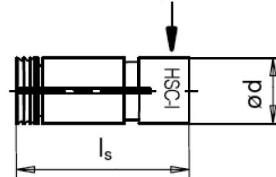

Setting

Installation equipment

Anchor size		HSC-I/IR M6x40	HSC-I/IR M8x40	HSC-I/IR M10x50	HSC-I/IR M10x60	HSC-I/IR M12x60
Rotary hammer for setting		TE 7-C; TE 7-A; TE 16; TE 16-C; TE 16-M; TE 25; TE 30; TE 35				TE 16; TE 16-C; TE 16-M; TE 25; TE 30; TE 35; TE 40; TE 40-AVR
Stop drill bit	TE-C HSC-B	14x40	16x40	18x50	18x60	20x60
Setting Tool	TE-C HSC-MW	14	16	18	18	20
Insert Tool	TE-C HSC-EW	14	16	18	18	20

Setting instruction

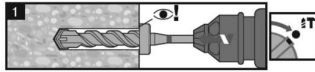

1.1	HSC-I/IR	TE 7	TE 16	TE 25	TE 40
		TE 7-A	TE 30	TE 35	
	M6 × 40	✓	✓	✓	
	M8 × 40	✓	✓	✓	
	M10 × 60	✓	✓	✓	
	M12 × 60	✓	✓	✓	✓

1.2	HSC-I/IR	TE-C-HSC-B	

	M6 × 40	14 × 40	
	M8 × 40	16 × 40	
	M10 × 50	18 × 50	
	M10 × 60	18 × 60	
	M12 × 60	20 × 60	

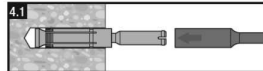
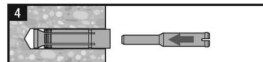
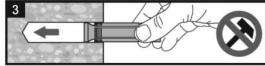
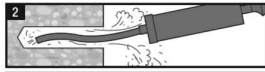

4.2	HSC-I/IR	EW		TE-C-HSC-MW	
		-----		-----	
	M6 × 40	14	14		
	M8 × 40	16	16		
	M10 × 50	18	18		
	M10 × 60	18	18		
	M12 × 60	20	20		

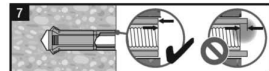
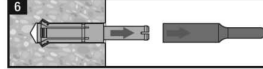

8.1	HSC-I/IR	L	
		M6	M8
	M6 × 40	6 ... 16 mm	
	M8 × 40	8 ... 22 mm	
	M10 × 50	10 ... 28 mm	
	M12 × 60	12 ... 30 mm	

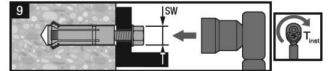

9.1	HSC-I/IR	SW	T _{max}	
			10	10 Nm
	M6 × 40	10	10 Nm	
	M8 × 40	13	10 Nm	
	M10 × 50	17	20 Nm	
	M10 × 60	17	30 Nm	
	M12 × 60	19	30 Nm	

For HSC-I: fastening carbon steel screw or threaded rod. Minimum strength class 8.8

For HSC-IR: fastening stainless steel screw or threaded rod: minimum strength class A4-70

For detailed information on installation see instruction for use given with the package of the product.

Setting details: depth of drill hole h_1 and effective anchorage depth h_{ef}

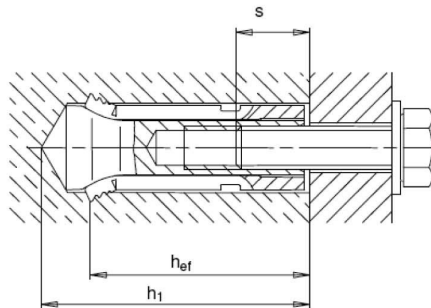

Setting details

Anchor version			M6x40	M8x40	M10x50	M10x60	M12x60
Nominal diameter of drill bit	d_0	[mm]	14	16	18	18	20
Cutting diameter of drill bit	$d_{cut} \leq$	[mm]	14,5	16,5	18,5	18,5	20,5
Depth of drill hole	$h_1 \geq$	[mm]	46	46	56	68	68
Diameter of clearance hole in the fixture	$d_f \leq$	[mm]	7	9	12	12	14
Effective anchorage depth	h_{ef}	[mm]	40	40	50	60	60
Screwing depth	min s	[mm]	6	8	10	10	12
	max s	[mm]	16	22	28	28	30
Width across	SW	[mm]	10	13	17	17	19
Installation torque	T_{inst}	[Nm]	10	10	20	30	30

Base material thickness, anchor spacing and edge distance

Anchor size			M6x40	M8x40	M10x50	M10x60	M12x60
Minimum base material thickness	h_{min}	[mm]	100	100	110	130	130
Minimum spacing	s_{min}	[mm]	40	40	50	60	60
Minimum edge distance	c_{min}	[mm]	40	40	50	60	60
Critical spacing for concrete cone failure	$s_{cr,N}$	[mm]	120	120	150	180	180
Critical edge distance for concrete cone failure	$c_{cr,N}$	[mm]	60	60	75	90	90
Critical spacing for splitting failure	$s_{cr,sp}$	[mm]	130	120	170	180	180
Critical edge distance for splitting failure	$c_{cr,sp}$	[mm]	65	60	85	90	90

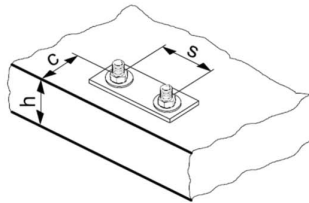

For spacing (edge distance) smaller than critical spacing (critical edge distance) the design loads have to be reduced.

Critical spacing and critical edge distance for splitting failure apply only for non-cracked concrete. For cracked concrete only the critical spacing and critical edge distance for concrete cone failure are decisive.

Simplified design method

Simplified version of the design method according ETAG 001, Annex C. Design resistance according data given in ETA-02/0027 issue 2012-09-20.

- Influence of concrete strength
- Influence of edge distance
- Influence of spacing
- Valid for a group of two anchors. (The method may also be applied for anchor groups with more than two anchors or more than one edge. The influencing factors must then be considered for each edge distance and spacing. The calculated design loads are then on the safe side: They will be lower than the exact values according ETAG 001, Annex C. To avoid this, it is recommended to use the anchor design software PROFIS anchor)

The design method is based on the following simplification:

- No different loads are acting on individual anchors (no eccentricity)

The values are valid for one anchor.

For more complex fastening applications please use the anchor design software PROFIS Anchor.

Tension loading

The design tensile resistance is the lower value of

- Steel resistance: $N_{Rd,s}$
- Concrete pull-out resistance: $N_{Rd,p} = N_{Rd,p}^0 \cdot f_B$
- Concrete cone resistance: $N_{Rd,c} = N_{Rd,c}^0 \cdot f_B \cdot f_{1,N} \cdot f_{2,N} \cdot f_{3,N} \cdot f_{re,N}$
- Concrete splitting resistance (only non-cracked concrete):
 $N_{Rd,sp} = N_{Rd,c}^0 \cdot f_B \cdot f_{1,sp} \cdot f_{2,sp} \cdot f_{3,sp} \cdot f_{h,sp} \cdot f_{re,N}$

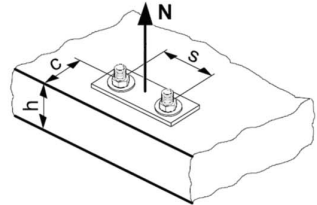

Basic design tensile resistance

Design steel resistance $N_{Rd,s}$

Anchor size		M6x40	M8x40	M10x50	M10x60	M12x60
$N_{Rd,s}$	HSC-I [kN]	10,7	16,3	20,2	20,2	24,3
	HSC-IR [kN]	7,5	11,4	14,2	14,2	17,1

Design pull-out resistance $N_{Rd,p} = N_{Rd,p}^0 \cdot f_B$

Anchor size	Non-cracked concrete					Cracked concrete				
	M6x40	M8x40	M10x50	M10x60	M12x60	M6x40	M8x40	M10x50	M10x60	M12x60
$N_{Rd,p}^0$ [kN]	No pull-out failure					No pull-out failure				

Design concrete cone resistance $N_{Rd,c} = N_{Rd,c}^0 \cdot f_B \cdot f_{1,N} \cdot f_{2,N} \cdot f_{3,N} \cdot f_{re,N}$

Design splitting resistance ^{a)} $N_{Rd,sp} = N_{Rd,c}^0 \cdot f_B \cdot f_{1,sp} \cdot f_{2,sp} \cdot f_{3,sp} \cdot f_{h,sp} \cdot f_{re,N}$

Anchor size	Non-cracked concrete					Cracked concrete				
	M6x40	M8x40	M10x50	M10x60	M12x60	M6x40	M8x40	M10x50	M10x60	M12x60
$N_{Rd,c}^0$ [kN]	8,5	8,5	11,9	15,6	15,6	6,1	6,1	8,5	11,2	11,2

- Splitting resistance must only be considered for non-cracked concrete

Influencing factors

Influence of concrete strength

Concrete strength designation (ENV 206)	C 20/25	C 25/30	C 30/37	C 35/45	C 40/50	C 45/55	C 50/60
$f_B = (f_{ck,cube}/25N/mm^2)^{1/2 \text{ a)}}$	1	1,1	1,22	1,34	1,41	1,48	1,55

- $f_{ck,cube}$ = concrete compressive strength, measured on cubes with 150 mm side length

Influence of edge distance ^{a)}

$c/c_{cr,N}$	0,1	0,2	0,3	0,4	0,5	0,6	0,7	0,8	0,9	1
$c/c_{cr,sp}$										
$f_{1,N} = 0,7 + 0,3 \cdot c/c_{cr,N} \leq 1$	0,73	0,76	0,79	0,82	0,85	0,88	0,91	0,94	0,97	1
$f_{1,sp} = 0,7 + 0,3 \cdot c/c_{cr,sp} \leq 1$										
$f_{2,N} = 0,5 \cdot (1 + c/c_{cr,N}) \leq 1$	0,55	0,60	0,65	0,70	0,75	0,80	0,85	0,90	0,95	1
$f_{2,sp} = 0,5 \cdot (1 + c/c_{cr,sp}) \leq 1$										

- The edge distance shall not be smaller than the minimum edge distance c_{min} given in the table with the setting details. These influencing factors must be considered for every edge distance.

Influence of anchor spacing ^{a)}

$s/s_{cr,N}$	0,1	0,2	0,3	0,4	0,5	0,6	0,7	0,8	0,9	1
$s/s_{cr,sp}$										
$f_{3,N} = 0,5 \cdot (1 + s/s_{cr,N}) \leq 1$	0,55	0,60	0,65	0,70	0,75	0,80	0,85	0,90	0,95	1
$f_{3,sp} = 0,5 \cdot (1 + s/s_{cr,sp}) \leq 1$										

- The anchor spacing shall not be smaller than the minimum anchor spacing s_{min} given in the table with the setting details. This influencing factor must be considered for every anchor spacing.

Influence of base material thickness

h/h_{ef}	2,0	2,2	2,4	2,6	2,8	3,0	3,2	3,4	3,6	≥ 3,68
$f_{h,sp} = [h/(2 \cdot h_{ef})]^{2/3}$	1	1,07	1,13	1,19	1,25	1,31	1,37	1,42	1,48	1,5

Influence of reinforcement

Anchor size	M6x40	M8x40	M10x50	M10x60	M12x60
$f_{re,N} = 0,5 + h_{ef}/200mm \leq 1$	0,7 ^{a)}	0,7 ^{a)}	0,75 ^{a)}	0,8 ^{a)}	0,8 ^{a)}

- This factor applies only for dense reinforcement. If in the area of anchorage there is reinforcement with a spacing ≥ 150 mm (any diameter) or with a diameter ≤ 10 mm and a spacing ≥ 100 mm, then a factor $f_{re,N} = 1$ may be applied.

Shear loading

The design shear resistance is the lower value of

- Steel resistance: $V_{Rd,s}$
- Concrete pryout resistance: $V_{Rd,cp} = k \cdot N_{Rd,c}$
- Concrete edge resistance: $V_{Rd,c} = V_{Rd,c}^0 \cdot f_B \cdot f_h \cdot f_4 \cdot f_{hef} \cdot f_c$

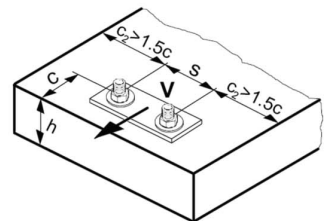

Basic design shear resistance

Design steel resistance $V_{Rd,s}$

Anchor size			M6x40	M8x40	M10x50	M10x60	M12x60
$V_{Rd,s}$	HSC-I	[kN]	6,4	9,8	12,2	12,2	14,6
	HSC-IR	[kN]	4,5	6,9	8,5	8,5	10,3

Design concrete pryout resistance $V_{Rd,cp} = k \cdot N_{Rd,c}^{a)}$

Anchor size		M6x40	M8x40	M10x50	M10x60	M12x60
k				2,0		

a) $N_{Rd,c}$: Design concrete cone resistance

Design concrete edge resistance $a) V_{Rd,c} = V_{Rd,c}^0 \cdot f_B \cdot f_{\beta} \cdot f_h \cdot f_4 \cdot f_{hef} \cdot f_c$

Anchor size		Non-cracked concrete					Cracked concrete				
		M6x40	M8x40	M10x50	M10x60	M12x60	M6x40	M8x40	M10x50	M10x60	M12x60
$V_{Rd,c}^0$	[kN]	14,9	18,5	22,6	22,7	27,0	10,5	13,1	16,0	16,1	19,1

- For anchor groups only the anchors close to the edge must be considered.

Influencing factors

Influence of concrete strength

Concrete strength designation (ENV 206)	C 20/25	C 25/30	C 30/37	C 35/45	C 40/50	C 45/55	C 50/60
$f_B = (f_{ck,cube}/25N/mm^2)^{1/2 a)}$	1	1,1	1,22	1,34	1,41	1,48	1,55

- $f_{ck,cube}$ = concrete compressive strength, measured on cubes with 150 mm side length

Influence of angle between load applied and the direction perpendicular to the free edge

Angle β	0°	10°	20°	30°	40°	50°	60°	70°	80°	≥ 90°
$f_{\beta} = \sqrt{\frac{1}{(\cos \alpha_r)^2 + \left(\frac{\sin \alpha_r}{2,5}\right)^2}}$	1	1,01	1,05	1,13	1,24	1,40	1,64	1,97	2,32	2,50

Influence of base material thickness

h/c	0,15	0,3	0,45	0,6	0,75	0,9	1,05	1,2	1,35	≥ 1,5
$f_h = \{h/(1,5 \cdot c)\}^{1/2} \leq 1$	0,32	0,45	0,55	0,63	0,71	0,77	0,84	0,89	0,95	1,00

Influence of anchor spacing and edge distance ^{a)} for concrete edge resistance: f_4
 $f_4 = (c/h_{ef})^{1,5} \cdot (1 + s / [3 \cdot c]) \cdot 0,5$

c/h _{ef}	Single anchor	Group of two anchors s/h _{ef}														
		0,75	1,50	2,25	3,00	3,75	4,50	5,25	6,00	6,75	7,50	8,25	9,00	9,75	10,50	11,25
0,50	0,35	0,27	0,35	0,35	0,35	0,35	0,35	0,35	0,35	0,35	0,35	0,35	0,35	0,35	0,35	0,35
0,75	0,65	0,43	0,54	0,65	0,65	0,65	0,65	0,65	0,65	0,65	0,65	0,65	0,65	0,65	0,65	0,65
1,00	1,00	0,63	0,75	0,88	1,00	1,00	1,00	1,00	1,00	1,00	1,00	1,00	1,00	1,00	1,00	1,00
1,25	1,40	0,84	0,98	1,12	1,26	1,40	1,40	1,40	1,40	1,40	1,40	1,40	1,40	1,40	1,40	1,40
1,50	1,84	1,07	1,22	1,38	1,53	1,68	1,84	1,84	1,84	1,84	1,84	1,84	1,84	1,84	1,84	1,84
1,75	2,32	1,32	1,49	1,65	1,82	1,98	2,15	2,32	2,32	2,32	2,32	2,32	2,32	2,32	2,32	2,32
2,00	2,83	1,59	1,77	1,94	2,12	2,30	2,47	2,65	2,83	2,83	2,83	2,83	2,83	2,83	2,83	2,83
2,25	3,38	1,88	2,06	2,25	2,44	2,63	2,81	3,00	3,19	3,38	3,38	3,38	3,38	3,38	3,38	3,38
2,50	3,95	2,17	2,37	2,57	2,77	2,96	3,16	3,36	3,56	3,76	3,95	3,95	3,95	3,95	3,95	3,95
2,75	4,56	2,49	2,69	2,90	3,11	3,32	3,52	3,73	3,94	4,15	4,35	4,56	4,56	4,56	4,56	4,56
3,00	5,20	2,81	3,03	3,25	3,46	3,68	3,90	4,11	4,33	4,55	4,76	4,98	5,20	5,20	5,20	5,20
3,25	5,86	3,15	3,38	3,61	3,83	4,06	4,28	4,51	4,73	4,96	5,18	5,41	5,63	5,86	5,86	5,86
3,50	6,55	3,51	3,74	3,98	4,21	4,44	4,68	4,91	5,14	5,38	5,61	5,85	6,08	6,31	6,55	6,55
3,75	7,26	3,87	4,12	4,36	4,60	4,84	5,08	5,33	5,57	5,81	6,05	6,29	6,54	6,78	7,02	7,26
4,00	8,00	4,25	4,50	4,75	5,00	5,25	5,50	5,75	6,00	6,25	6,50	6,75	7,00	7,25	7,50	7,75
4,25	8,76	4,64	4,90	5,15	5,41	5,67	5,93	6,18	6,44	6,70	6,96	7,22	7,47	7,73	7,99	8,25
4,50	9,55	5,04	5,30	5,57	5,83	6,10	6,36	6,63	6,89	7,16	7,42	7,69	7,95	8,22	8,49	8,75
4,75	10,35	5,45	5,72	5,99	6,27	6,54	6,81	7,08	7,36	7,63	7,90	8,17	8,45	8,72	8,99	9,26
5,00	11,18	5,87	6,15	6,43	6,71	6,99	7,27	7,55	7,83	8,11	8,39	8,66	8,94	9,22	9,50	9,78
5,25	12,03	6,30	6,59	6,87	7,16	7,45	7,73	8,02	8,31	8,59	8,88	9,17	9,45	9,74	10,02	10,31
5,50	12,90	6,74	7,04	7,33	7,62	7,92	8,21	8,50	8,79	9,09	9,38	9,67	9,97	10,26	10,55	10,85

- The anchor spacing and the edge distance shall not be smaller than the minimum anchor spacing s_{min} and the minimum edge distance c_{min} .

Influence of embedment depth

Anchor size	M6x40	M8x40	M10x50	M10x60	M12x60
$f_{hef} = 0,05 \cdot (h_{ef} / d)^{1,68}$	0,29	0,23	0,28	0,38	0,32

Influence of edge distance ^{a)}

c/d	4	6	8	10	15	20	30	40
$f_c = (d / c)^{0,19}$	0,77	0,71	0,67	0,65	0,60	0,57	0,52	0,50

a) The edge distance shall not be smaller than the minimum edge distance c_{min} .

Combined tension and shear loading

For combined tension and shear loading see section "Anchor Design".

