

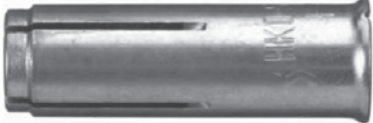

HKD Push-in anchor, Single anchor application

	Anchor version	Benefits
	HKD Carbon steel with lip	<ul style="list-style-type: none"> - simple and well proven - approved, tested and confirmed by everyday jobsite experience - reliable setting thanks to simple visual check - versatile - for medium-duty fastening with bolts or threaded rods - available in various materials and sizes for maximized coverage of possible applications
	HKD-S(R) Carbon steel, stainless steel with lip	
	HKD-E(R) Carbon steel, stainless steel without lip	



Concrete



Corrosion
resistance



European
Technical
Approval



CE
conformity



PROFIS
Anchor
design
software

Approvals / certificates

Description	Authority / Laboratory	No. / date of issue
European technical approval ^{a)}	DIBt, Berlin	ETA-02/0032 / 2012-10-18

a) Anchors with anchorage depth $h_{ef} = 25\text{mm}$ are not covered by ETA

Basic loading data (for a single anchor)

All data in this section applies to

- Correct setting (See setting instruction)
- No edge distance and spacing influence
- Concrete as specified in the table
- Steel failure
- Minimum base material thickness
- Concrete C 20/25, $f_{ck,cube} = 25 \text{ N/mm}^2$
- screw or rod with steel strength 5.8 (carbon steel) and/or A4-70 (stainless steel)

For details see Simplified design method

Mean Ultimate Resistance

Anchor size		Hilti technical data											
		M6x25	M8x25	M10x25	M12x25	M6x30	M8x30	M8x40	M10x30	M10x40	M12x50	M16x65	M20x80
Tensile $N_{Ru,m}$													
HKD	[kN]	8,4	8,4	8,4	8,4	-	11,0	13,1	11,0	17,0	23,8	32,9	48,1
HKD-S, HKD-E	[kN]	8,2	-	-	-	10,6	10,8	16,6	10,8	16,6	23,3	34,5	47,1
HKD-SR, HKD-ER	[kN]	8,2	-	-	-	10,6	10,8	-	-	16,6	23,3	34,5	47,1
Shear $V_{Ru,m}$													
HKD	[kN]	5,5	6,9	6,9	6,9	-	9,4	10,1	11,0	12,2	20,1	37,1	53,9
HKD-S, HKD-E	[kN]	6,5	-	-	-	6,5	9,1	9,1	9,6	10,4	18,3	28,5	45,1
HKD-SR, HKD-ER	[kN]	8,3	-	-	-	7,0	10,9	-	-	13,7	24,3	41,7	66,3

Characteristic Resistance

Anchor size		Hilti technical data				according ETA-02/0032, issue 2012-10-18							
		M6x25	M8x25	M10x25	M12x25	M6x30	M8x30	M8x40	M10x30	M10x40	M12x50	M16x65	M20x80
Tensile N_{Rk}													
HKD	[kN]	6,3	6,3	6,3	6,3	-	8,3	9,0	8,3	12,8	17,8	26,4	36,1
HKD-S, HKD-E	[kN]	6,3	-	-	-	8,3	8,3	9,0	8,3	12,8	17,8	26,4	36,1
HKD-SR, HKD-ER	[kN]	6,3	-	-	-	8,3	8,3	-	-	12,8	17,8	26,4	36,1
Shear V_{Rk}													
HKD	[kN]	5,0	6,3	6,3	6,3	-	8,6	9,2	10,0	11,0	18,3	33,8	49,0
HKD-S, HKD-E	[kN]	5,0	-	-	-	5,0	7,0	7,0	7,4	8,0	14,1	21,9	34,7
HKD-SR, HKD-ER	[kN]	6,2	-	-	-	6,4	8,4	-	-	10,5	18,7	32,1	51,0

Design Resistance

Anchor size		Hilti technical data				according ETA-02/0032, issue 2012-10-18							
		M6x25	M8x25	M10x25	M12x25	M6x30	M8x30	M8x40	M10x30	M10x40	M12x50	M16x65	M20x80
Tensile N_{Rd}													
HKD	[kN]	4,2	4,2	4,2	4,2	-	5,5	6,0	5,5	8,5	11,9	17,6	24,0
HKD-S, HKD-E	[kN]	3,0	-	-	-	4,6	4,6	5,0	4,6	7,1	9,9	17,6	24,0
HKD-SR, HKD-ER	[kN]	3,0	-	-	-	4,6	4,6	-	-	7,1	9,9	17,6	24,0
Shear V_{Rd}													
HKD	[kN]	4,0	4,2	4,2	4,2	-	6,9	7,3	8,0	8,8	14,6	27,0	39,4
HKD-S, HKD-E	[kN]	3,9	-	-	-	3,9	5,5	5,5	5,9	6,4	11,3	17,5	27,8
HKD-SR, HKD-ER	[kN]	4,1	-	-	-	4,2	5,5	-	-	6,9	12,3	21,1	33,6

Recommended load

Anchor size	Hilti technical data				according ETA-02/0032, issue 2012-10-18							
	M6x25	M8x25	M10x25	M12x25	M6x30	M8x30	M8x40	M10x30	M10x40	M12x50	M16x65	M20x80
Tensile N_{rec}^a												
HKD [kN]	3,0	3,0	3,0	3,0	-	3,9	4,3	3,9	6,1	8,5	12,6	17,2
HKD-S, HKD-E [kN]	2,1	-	-	-	3,3	3,3	3,6	3,3	5,1	7,1	12,6	17,2
HKD-SR, HKD-ER [kN]	2,1	-	-	-	3,3	3,3	-	-	5,1	7,1	12,6	17,2
Shear V_{rec}^a												
HKD [kN]	2,9	3,0	3,0	3,0	-	4,9	5,2	5,7	6,3	10,5	19,3	28,3
HKD-S, HKD-E [kN]	2,8	-	-	-	2,8	3,9	4,2	3,9	4,6	8,1	12,5	19,8
HKD-SR, HKD-ER [kN]	2,9	-	-	-	3,0	3,9	-	-	4,9	8,8	15,1	24,0

a) With overall partial safety factor for action $\gamma = 1,4$. The partial safety factors for action depend on the type of loading and shall be taken from national regulations.

Materials

Mechanical properties of HKD, HKD-S, HKS-E, HKD-SR and HKD-ER

Anchor size			M6	M8	M10	M12	M16	M20
Nominal tensile strength f_{uk}	HKD [N/mm ²]		570	570	570	570	640	590
	HKD-S [N/mm ²]		560	560	510	510	-	460
	HKD-E [N/mm ²]							
	HKD-SR [N/mm ²]		540	540	540	540	-	540
Yield strength f_{yk}	HKD [N/mm ²]		460	460	460	480	510	470
	HKD-S [N/mm ²]		440	440	410	410	-	375
	HKD-E [N/mm ²]							
	HKD-SR [N/mm ²]		355	355	355	355	-	355
Stressed cross-section A_s	HKD [mm ²]		20,7	26,7	32,7	60,1	105	167
	HKD-S (R) [mm ²]		20,9	26,1	28,8	58,7	-	163
Moment of resistance W	HKD [mm ³]		32,3	54,6	82,9	184	431	850
	HKD-S (R) [mm ³]		50	79	110	264	602	1191
Char. bending resistance for rod or bolt $M_{Rk,s}^0$	With 5.8 Gr. Steel [Nm]		7,6	18,7	37,4	65,5	167	325
	HKD-SR [Nm]		11	26	52	92	187	454
	HKD-ER with A4-70 [Nm]							

Material quality

Part		Material
Anchor Body	HKD	Steel Fe/Zn5 galvanised to min. 5 µm
	HKD-S HKD-E	Steel Fe/Zn5 galvanised to min. 5 µm
	HKD-SR HKD-ER	Stainless steel, 1.4401, 1.4404, 1.4571
Tapered expansion plug	HKD	Steel material
	HKD-S HKD-E	Steel material
	HKD-SR HKD-ER	Stainless steel, 1.4401, 1.4404, 1.4571

Anchor dimensions

Anchor size Anchor version			M6x25	M8x25	M10x25	M12x25	M6x30	M8x30	M8x40	M10x30	M10x40	M12x50	M16x65	M20x80
Effective anchorage depth	h_{ef}	[mm]	25	25	25	25	30	30	40	30	40	50	60	80
Anchor diameter	d_1	[mm]	7,9	9,95	11,9	14,9	8	9,95	9,95	11,8	11,95	14,9	19,75	24,75
Plug diameter	d_2	[mm]	5,1	6,35	8,1	9,7	5	6,5	6,35	8,2	8,2	10,3	13,8	16,4
Plug length	l_1	[mm]	10	7	7	7,2	15	12	16	12	16	20	29	30

Anchor body

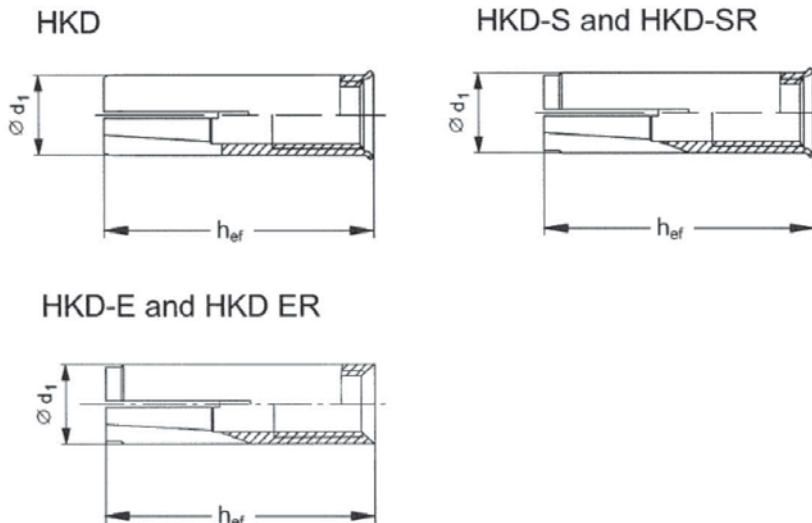

Expansions plugs

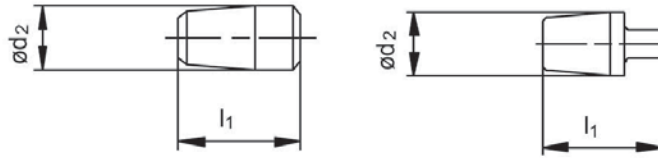

Setting

Installation equipment

Anchor size	M6x25	M6x30	M8x25	M8x30	M8x40	M10x25	M10x30	M10x40	M12x25	M12x50	M16x65	M20x80
Rotary hammer	TE 2 – TE 16										TE 40 – 80	
Machine setting tool HSD-M	6x25/30	8x25/30	8x40	10x25/30	10x40	12x25	12x50	16x65	20x80			
Hand Setting tool HSD-G												
Other tools	hammer, torque wrench, blow out pump											

Setting instruction

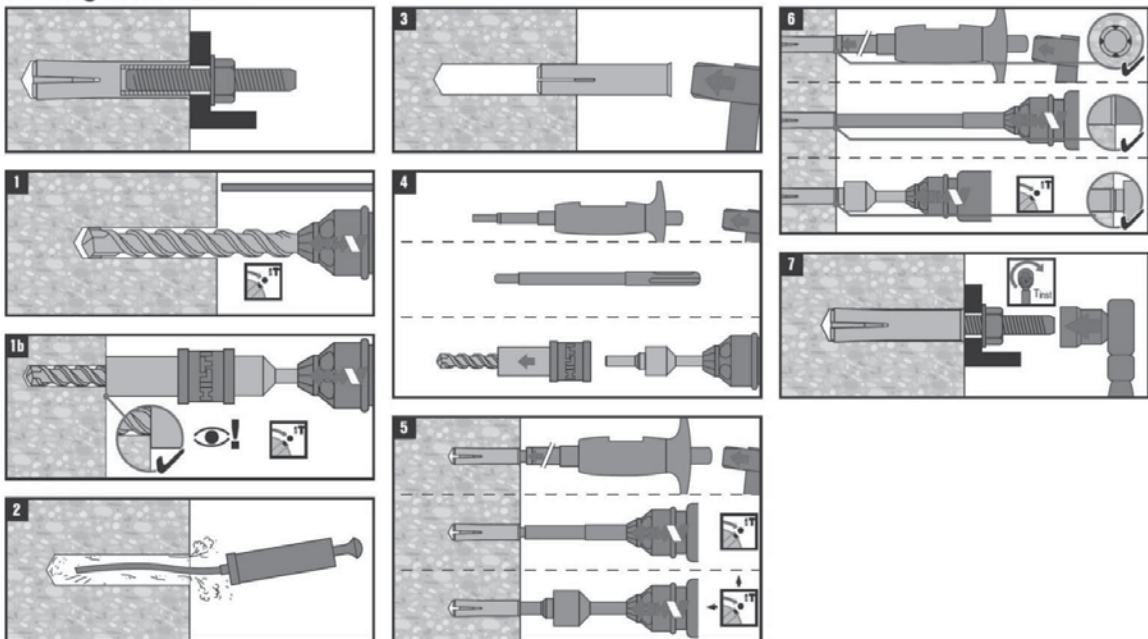

For detailed information on installation see instruction for use given with the package of the product.

For technical data for anchors in diamond drilled holes please contact the Hilti Technical advisory service.

Setting details: depth of drill hole h_1 and effective anchorage depth h_{ef}

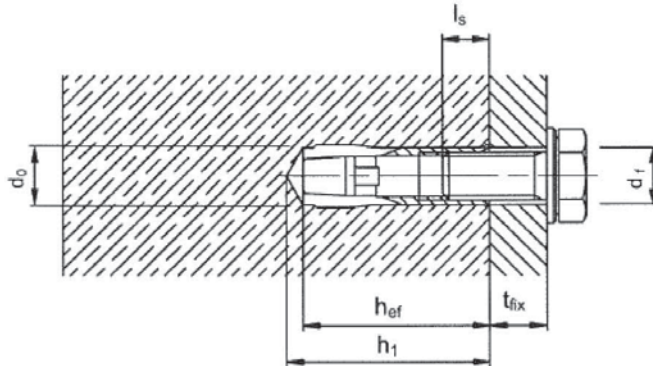

Setting details

Anchor size		M6x25	M8x25	M10x25	M12x25	M6x30	M8x30	M8x40	M10x30	M10x40	M12x50	M16x65	M20x80
Nominal diameter of drill bit	d_o [mm]	8	10	12	15	8	10	10	12	12	15	20	25
Cutting diameter of drill bit	$d_{cut} \leq$ [mm]	8,45	10,5	12,5	15,5	8,45	10,5	10,5	12,5	12,5	15,5	20,5	25,5
Depth of drill hole	$h_1 \geq$ [mm]	27	27	27	27	32	33	43	33	43	54	70	85
Screwing depth	$l_{s,min}$ [mm]	6	8	10	12	6	8	8	10	10	12	16	20
	$l_{s,max}$ [mm]	12	11,5	12	12	12,5	14,5	17,5	13	18	22	30,5	42
Diameter of clearance hole in the fixture	$d_f \leq$ [mm]	7	9	12	14	7	9	9	12	12	14	18	22
Effective anchorage depth	h_{ef} [mm]	25	25	25	25	30	30	40	30	40	50	65	80
Max. torque moment	T_{inst} [Nm]	4	8	15	35	4	8	8	15	15	35	60	120

Base material thickness, anchor spacing and edge distances

Anchor size			M6x25 M8x25 M10x25 M12x25	M6x30 M8x30 M10x30	M8x40 M10x40	M12x50	M16x65	M20x80	
Minimum base material thickness	h_{min}	[mm]	100	100	100	100	130	160	
Minimum spacing and minimum edge distance HKD-S (R) HKD-E (R)	s_{min}	[mm]	60	60	80	125	130	160	
	c_{min}	[mm]	88	105	140	175	230	280	
Minimum spacing HKD	s_{min}	[mm]	80	60	80	125	130	160	
	for $c \geq$	[mm]	140	105	140	175	230	280	
Minimum edge distance HKD	c_{min}	[mm]	100	80	140	175	230	280	
	for $s \geq$	[mm]	150	120	80	125	130	160	
Critical spacing and edge distance for concrete cone failure	$s_{cr,N}$	[mm]	80	90	120	150	200	240	
	$c_{cr,N}$	[mm]	40	45	60	75	100	120	
Critical spacing and edge distance for splitting failure	HKD	$s_{cr,sp}$	[mm]	200	210	280	350	455	560
		$c_{cr,sp}$	[mm]	100	105	140	175	227	280
	HKD-S (R) HKD-E (R)	$s_{cr,sp}$	[mm]	176	210	280	350	455	560
		$c_{cr,sp}$	[mm]	88	105	140	175	227	280

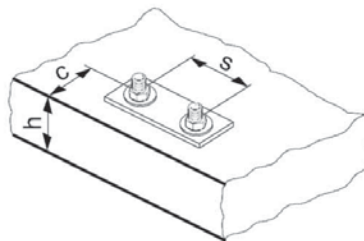

For spacing (edge distance) smaller than critical spacing (critical edge distance) the design loads have to be reduced.

Simplified design method

Simplified version of the design method according ETAG 001, Annex C. Design resistance according data given in ETA-02/0032, issue 2012-10-18.

- Influence of concrete strength
- Influence of edge distance
- Influence of spacing
- Valid for a group of two anchors. (The method may also be applied for anchor groups with more than two anchors or more than one edge. The influencing factors must then be considered for each edge distance and spacing. The calculated design loads are then on the same side: They will be lower than the exact values according ETAG 001, Annex C. To avoid this, it is recommended to use the anchor design software PROFIS anchor)

The design method is based on the following simplification:

- No different loads are acting on individual anchors (no eccentricity)

The values are valid for one anchor.

For more complex fastening applications please use the anchor design software PROFIS Anchor.

Tension loading

The design tensile resistance is the lower value of

- Steel resistance: $N_{Rd,s}$
- Concrete pull-out resistance: $N_{Rd,p} = N_{Rd,p}^0 \cdot f_B$
- Concrete cone resistance: $N_{Rd,c} = N_{Rd,c}^0 \cdot f_B \cdot f_{1,N} \cdot f_{2,N} \cdot f_{3,N} \cdot f_{re,N}$
- Concrete splitting resistance (only non-cracked concrete):
 $N_{Rd,sp} = N_{Rd,c}^0 \cdot f_B \cdot f_{1,sp} \cdot f_{2,sp} \cdot f_{3,sp} \cdot f_{h,sp} \cdot f_{re,N}$

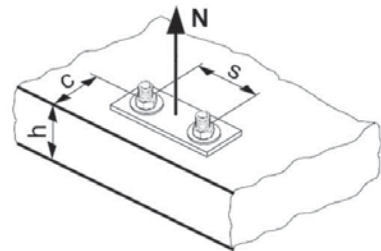

Basic design tensile resistance

Design steel resistance $N_{Rd,s}$ for HKD / HKD-E/S Steel Strength 5.8 and for HKD-ER/SR A4-70

Anchor size			Hilti technical data				according ETA-02/0032, issue 2012-10-18							
			M6x25	M8x25	M10x25	M12x25	M6x30	M8x30	M8x40	M10x30	M10x40	M12x50	M16x65	M20x80
$N_{Rd,s}$	HKD	[kN]	6,7	10,3	12,6	23,6	-	11,4	12,2	13,3	14,7	24,4	45,0	65,3
	HKD-S, HKD-E	[kN]	6,7	-	-	-	6,7	11,4	11,4	12,4	13,4	23,7	37,2	59,1
	HKD-SR, HKD-ER	[kN]	6,9	-	-	-	7,0	9,2	-	-	11,5	20,4	35,1	55,7

Design pull-out resistance $N_{Rd,p} = N_{Rd,p}^0 \cdot f_B$

			Non-cracked concrete											
			Hilti technical data				according ETA-02/0032, issue 2012-10-18							
Anchor size			M6x25	M8x25	M10x25	M12x25	M6x30	M8x30	M8x40	M10x30	M10x40	M12x50	M16x65	M20x80
$N_{Rd,p}^0$	HKD	[kN]	-	-	-	-	-	-	6,0	-	-	-	-	-
	HKD-S, HKD-E	[kN]	-	-	-	-	-	-	5,0	-	-	-	-	-
	HKD-SR, HKD-ER	[kN]	-	-	-	-	-	-	-	-	-	-	-	-

Design concrete cone resistance $N_{Rd,c} = N_{Rd,c}^0 \cdot f_B \cdot f_{1,N} \cdot f_{2,N} \cdot f_{3,N} \cdot f_{re,N}$

Design splitting resistance^{a)} $N_{Rd,sp} = N_{Rd,c}^0 \cdot f_B \cdot f_{1,sp} \cdot f_{2,sp} \cdot f_{3,sp} \cdot f_{h,sp} \cdot f_{re}$

			Non-cracked concrete											
			Hilti technical data				according ETA-02/0032, issue 2012-10-18							
Anchor size			M6x25	M8x25	M10x25	M12x25	M6x30	M8x30	M8x40	M10x30	M10x40	M12x50	M16x65	M20x80
$N_{Rd,c}^0$	HKD	[kN]	4,2	4,2	4,2	4,2	-	5,5	8,5	5,5	8,5	11,9	17,6	24,0
	HKD-S, HKD-E	[kN]	3,0	-	-	-	4,6	4,6	7,1	4,6	7,1	9,9	17,6	24,0
	HKD-SR, HKD-ER	[kN]	3,0	-	-	-	4,6	4,6	-	-	7,1	9,9	17,6	24,0

a) Splitting resistance must only be considered for non-cracked concrete

Influencing factors

Influence of concrete strength

Concrete strength designation (ENV 206)	C 20/25	C 25/30	C 30/37	C 35/45	C 40/50	C 45/55	C 50/60
$f_B = (f_{ck,cube}/25N/mm^2)^{1/2}$ a)	1	1,1	1,22	1,34	1,41	1,48	1,55

a) $f_{ck,cube}$ = concrete compressive strength, measured on cubes with 150 mm side length

Influence of edge distance^{a)}

$c/c_{cr,N}$	0,1	0,2	0,3	0,4	0,5	0,6	0,7	0,8	0,9	1
$c/c_{cr,sp}$										
$f_{1,N} = 0,7 + 0,3 \cdot c/c_{cr,N} \leq 1$	0,73	0,76	0,79	0,82	0,85	0,88	0,91	0,94	0,97	1
$f_{1,sp} = 0,7 + 0,3 \cdot c/c_{cr,sp} \leq 1$										
$f_{2,N} = 0,5 \cdot (1 + c/c_{cr,N}) \leq 1$	0,55	0,60	0,65	0,70	0,75	0,80	0,85	0,90	0,95	1
$f_{2,sp} = 0,5 \cdot (1 + c/c_{cr,sp}) \leq 1$										

a) The edge distance shall not be smaller than the minimum edge distance c_{min} given in the table with the setting details. These influencing factors must be considered for every edge distance.

Influence of anchor spacing ^{a)}

$s/s_{cr,N}$	0,1	0,2	0,3	0,4	0,5	0,6	0,7	0,8	0,9	1
$s/s_{cr,sp}$										
$f_{3,N} = 0,5 \cdot (1 + s/s_{cr,N}) \leq 1$	0,55	0,60	0,65	0,70	0,75	0,80	0,85	0,90	0,95	1
$f_{3,sp} = 0,5 \cdot (1 + s/s_{cr,sp}) \leq 1$										

a) The anchor spacing shall not be smaller than the minimum anchoring spacing s_{min} given in the table with the setting details. This influencing factor must be considered for every anchor spacing.

Influence of base material thickness

h/h_{ef}	2,0	2,2	2,4	2,6	2,8	3,0	3,2	3,4	3,6	$\geq 3,68$
$f_{h,sp} = [h/(2 \cdot h_{ef})]^{2/3}$	1	1,07	1,13	1,19	1,25	1,31	1,37	1,42	1,48	1,5

Influence of reinforcement

Anchor size	M6x25	M8x25	M10x25	M12x25	M6x30	M8x30	M8x40	M10x30	M10x40	M12x50	M16x65	M20x80
$f_{re,N} = 0,5 + h_{ef}/200\text{mm} \leq 1$	0,63 ^{a)}	0,63 ^{a)}	0,63 ^{a)}	0,63 ^{a)}	0,65 ^{a)}	0,65 ^{a)}	0,7 ^{a)}	0,65 ^{a)}	0,7 ^{a)}	0,75 ^{a)}	0,83 ^{a)}	0,9 ^{a)}

a) This factor applies only for dense reinforcement. If in the area of anchorage there is reinforcement with a spacing ≥ 150 mm (any diameter) or with a diameter ≤ 10 mm and a spacing ≥ 100 mm, then a factor $f_{re,N} = 1$ may be applied.

Shear loading

The design shear resistance is the lower value of

- Steel resistance: $V_{Rd,s}$
- Concrete pryout resistance: $V_{Rd,cp} = k \cdot N_{Rd,c}$
- Concrete edge resistance: $V_{Rd,c} = V_{Rd,c}^0 \cdot f_B \cdot f_{B'} \cdot f_h \cdot f_4 \cdot f_{hef} \cdot f_c$

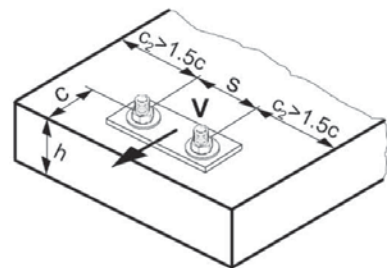

Basic design shear resistance

Design steel resistance $V_{Rd,s}$ for HKD / HKD-E/S Steel Strength 5.8 and for HKD-ER/SR A4-70

			Hilti technical data				according ETA-02/0032, issue 2012-10-18							
Anchor size			M6x25	M8x25	M10x25	M12x25	M6x30	M8x30	M8x40	M10x30	M10x40	M12x50	M16x65	M20x80
$V_{Rd,s}$	HKD	[kN]	4,0	6,2	7,5	14,1	-	6,9	7,3	8,0	8,8	14,6	27,0	39,6
	HKD-S, HKD-E	[kN]	3,9	-	-	-	3,9	5,5	5,5	5,9	6,4	11,3	17,5	27,8
	HKD-SR, HKD-ER	[kN]	4,1	-	-	-	4,2	5,5	-	-	6,9	12,3	21,1	33,6

Design concrete pryout resistance $V_{Rd,cp} = k \cdot N_{Rd,c}$ ^{a)}

Anchor size	Hilti technical data				according ETA-02/0032, issue 2012-10-18							
	M6x25	M8x25	M10x25	M12x25	M6x30	M8x30	M8x40	M10x30	M10x40	M12x50	M16x65	M20x80
k	1				2							

a) $N_{Rd,c}$: Design concrete cone resistance

Design concrete edge resistance^{a)} $V_{Rd,c} = V_{Rd,c}^0 \cdot f_B \cdot f_\beta \cdot f_h \cdot f_4 \cdot f_{hef} \cdot f_c$

Anchor size	M6x25	M8x25	M10x25	M12x25	M6x30	M8x30	M8x40	M10x30	M10x40	M12x50	M16x65	M20x80
$V_{Rd,c}^0$ [kN]	5,8	8,4	11,3	16,4	5,9	8,5	8,5	11,4	11,5	16,8	27,1	39,2

a) For anchor groups only the anchors close to the edge must be considered

Influencing factors

Influence of concrete strength

Concrete strength designation (ENV 206)	C 20/25	C 25/30	C 30/37	C 35/45	C 40/50	C 45/55	C 50/60
$f_B = (f_{ck,cube}/25N/mm^2)^{1/2}$ ^{a)}	1	1,1	1,22	1,34	1,41	1,48	1,55

a) $f_{ck,cube}$ = concrete compressive strength, measured on cubes with 150 mm side length

Influence of angle between load applied and the direction perpendicular to the free edge

Angle β	0°	10°	20°	30°	40°	50°	60°	70°	80°	≥ 90°
$f_\beta = \sqrt{\frac{1}{(\cos \alpha_f)^2 + \left(\frac{\sin \alpha_f}{2,5}\right)^2}}$	1	1,01	1,05	1,13	1,24	1,40	1,64	1,97	2,32	2,50

Influence of base material thickness

h/c	0,15	0,3	0,45	0,6	0,75	0,9	1,05	1,2	1,35	≥ 1,5
$f_h = \{h/(1,5 \cdot c)\}^{1/2} \leq 1$	0,32	0,45	0,55	0,63	0,71	0,77	0,84	0,89	0,95	1,00

Influence of anchor spacing and edge distance ^{a)} for concrete edge resistance: f_4
 $f_4 = (c/h_{ef})^{1,5} \cdot (1 + s / [3 \cdot c]) \cdot 0,5$

c/h _{ef}	Single anchor	Group of two anchors s/h _{ef}														
		0.75	1.50	2.25	3.00	3.75	4.50	5.25	6.00	6.75	7.50	8.25	9.00	9.75	10.50	11.25
0,50	0,35	0,27	0,35	0,35	0,35	0,35	0,35	0,35	0,35	0,35	0,35	0,35	0,35	0,35	0,35	0,35
0,75	0,65	0,43	0,54	0,65	0,65	0,65	0,65	0,65	0,65	0,65	0,65	0,65	0,65	0,65	0,65	0,65
1,00	1,00	0,63	0,75	0,88	1,00	1,00	1,00	1,00	1,00	1,00	1,00	1,00	1,00	1,00	1,00	1,00
1,25	1,40	0,84	0,98	1,12	1,26	1,40	1,40	1,40	1,40	1,40	1,40	1,40	1,40	1,40	1,40	1,40
1,50	1,84	1,07	1,22	1,38	1,53	1,68	1,84	1,84	1,84	1,84	1,84	1,84	1,84	1,84	1,84	1,84
1,75	2,32	1,32	1,49	1,65	1,82	1,98	2,15	2,32	2,32	2,32	2,32	2,32	2,32	2,32	2,32	2,32
2,00	2,83	1,59	1,77	1,94	2,12	2,30	2,47	2,65	2,83	2,83	2,83	2,83	2,83	2,83	2,83	2,83
2,25	3,38	1,88	2,06	2,25	2,44	2,63	2,81	3,00	3,19	3,38	3,38	3,38	3,38	3,38	3,38	3,38
2,50	3,95	2,17	2,37	2,57	2,77	2,96	3,16	3,36	3,56	3,76	3,95	3,95	3,95	3,95	3,95	3,95
2,75	4,56	2,49	2,69	2,90	3,11	3,32	3,52	3,73	3,94	4,15	4,35	4,56	4,56	4,56	4,56	4,56
3,00	5,20	2,81	3,03	3,25	3,46	3,68	3,90	4,11	4,33	4,55	4,76	4,98	5,20	5,20	5,20	5,20
3,25	5,86	3,15	3,38	3,61	3,83	4,06	4,28	4,51	4,73	4,96	5,18	5,41	5,63	5,86	5,86	5,86
3,50	6,55	3,51	3,74	3,98	4,21	4,44	4,68	4,91	5,14	5,38	5,61	5,85	6,08	6,31	6,55	6,55
3,75	7,26	3,87	4,12	4,36	4,60	4,84	5,08	5,33	5,57	5,81	6,05	6,29	6,54	6,78	7,02	7,26
4,00	8,00	4,25	4,50	4,75	5,00	5,25	5,50	5,75	6,00	6,25	6,50	6,75	7,00	7,25	7,50	7,75
4,25	8,76	4,64	4,90	5,15	5,41	5,67	5,93	6,18	6,44	6,70	6,96	7,22	7,47	7,73	7,99	8,25
4,50	9,55	5,04	5,30	5,57	5,83	6,10	6,36	6,63	6,89	7,16	7,42	7,69	7,95	8,22	8,49	8,75
4,75	10,35	5,45	5,72	5,99	6,27	6,54	6,81	7,08	7,36	7,63	7,90	8,17	8,45	8,72	8,99	9,26
5,00	11,18	5,87	6,15	6,43	6,71	6,99	7,27	7,55	7,83	8,11	8,39	8,66	8,94	9,22	9,50	9,78
5,25	12,03	6,30	6,59	6,87	7,16	7,45	7,73	8,02	8,31	8,59	8,88	9,17	9,45	9,74	10,02	10,31
5,50	12,90	6,74	7,04	7,33	7,62	7,92	8,21	8,50	8,79	9,09	9,38	9,67	9,97	10,26	10,55	10,85

a) The anchor spacing and the edge distance shall not be smaller than the minimum anchor spacing s_{min} and the minimum edge distance c_{min} .

Influence of embedment depth

Anchor size	M6x25	M8x25	M10x25	M12x25	M6x30	M8x30	M8x40	M10x30	M10x40	M12x50	M16x65	M20x80
$f_{hef} = 0,05 \cdot (h_{ef} / d)^{1,68}$	0,34	0,23	0,17	0,12	0,46	0,32	0,51	0,23	0,38	0,38	0,36	0,35

Influence of edge distance ^{a)}



c/d	4	6	8	10	15	20	30	40
$f_c = (d / c)^{0,19}$	0,77	0,71	0,67	0,65	0,60	0,57	0,52	0,50

a) The edge distance shall not be smaller than the minimum edge distance c_{min} .

Combined tension and shear loading

For combined tension and shear loading see section "Anchor Design".

HKD Push-in anchor, Redundant fastening

	Anchor version	Benefits
	HKD Carbon steel with lip	<ul style="list-style-type: none"> - simple and well proven - approved, tested and confirmed by everyday jobsite experience - reliable setting thanks to simple visual check - versatile - for medium-duty fastening with bolts or threaded rods - available in various materials and sizes for maximized coverage of possible applications
	HKD-S(R) Carbon steel, stainless steel with lip	
	HKD-E(R) Carbon steel, stainless steel without lip	



Concrete



Tensile zone



Redundant fastening



Fire resistance

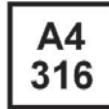

Corrosion resistance



Sprinkler approved



European Technical Approval



CE conformity

a) Redundant fastening only

Approvals / certificates

Description	Authority / Laboratory	No. / date of issue
European technical approval ^{a)}	DIBt, Berlin	ETA-06/0047 / 2012-23-28
Fire test report	DIBt, Berlin	ETA-06/0047 / 2012-23-28
Assessment report (fire)	warringtonfire	WF 327804/A / 2013-07-10

a) All data given in this section for HKD-S(R) and HKD-E(R), according ETA-06/0047, issue 2012-09-28. The anchor is to be used only for redundant fastening for non-structural applications.

Basic loading data for all load directions according design method B of ETAG 001

All data in this section applies to

- Correct setting (See setting instruction)
- No edge distance and spacing influence
- Concrete C 20/25 $f_{ck,cube} = 25 \text{ N/mm}^2$ to C50/60, $f_{ck,cube} = 60 \text{ N/mm}^2$
- Minimum base material thickness
- Anchors in redundant fastening

Characteristic Resistance, all load directions

Anchor size		M6x25	M6x30	M8x25	M8x30	M8x40	M10x25	M10x30	M10x40	M12x25	M12x50	M16x65
Load F_{Rk}												
HKD	kN	2,0	-	3,0	5,0	5,0	4,0	5,0	7,5	4,0	9,0	16,0
HKD-S, HKD-E	kN	-	3,0	-	3,0	5,0	-	4,0	6,0	-	6,0	-
HKD-SR, HKD-ER	kN	-	3,0	-	3,0	-	-	-	6,0	-	6,0	-

Design Resistance, all load directions

Anchor size		M6x25	M6x30	M8x25	M8x30	M8x40	M10x25	M10x30	M10x40	M12x25	M12x50	M16x65
Load F_{Rd}												
HKD	kN	1,3	-	2,0	2,8	3,3	2,2	3,3	5,0	2,7	6,0	10,7
HKD-S, HKD-E	kN	-	2,0	-	2,0	3,3	-	2,7	4,0	-	4,0	-
HKD-SR, HKD-ER	kN	-	2,0	-	2,0	-	-	-	4,0	-	4,0	-

Recommended loads ^{a)}, all load directions

Anchor size		M6x25	M6x30	M8x25	M8x30	M8x40	M10x25	M10x30	M10x40	M12x25	M12x50	M16x65
Load F_{rec}												
HKD	kN	1,0	-	1,4	2,0	2,4	1,6	2,4	3,6	1,9	4,3	7,6
HKD-S, HKD-E	kN	-	1,4	-	1,4	2,4	-	1,9	2,9	-	2,9	-
HKD-SR, HKD-ER	kN	-	1,4	-	1,4	-	-	-	2,9	-	2,9	-

a) With overall partial safety factor for action $\gamma = 1,4$. The partial safety factors for action depend on the type of loading and shall be taken from national regulations.

Requirements for redundant fastening

The definition of redundant fastening according to Member States is given in the ETAG 001 Part six, Annex 1. In Absence of a definition by a Member State the following default values may be taken

Minimum number of fixing points	Minimum number of anchors per fixing point	Maximum design load of action N_{Sd} per fixing point ^{a)}
3	1	2 kN
4	1	3 kN

a) The value for maximum design load of actions per fastening point N_{Sd} is valid in general that means all fastening points are considered in the design of the redundant structural system. The value N_{Sd} may be increased if the failure of one (= most unfavourable) fixing point is taken into account in the design (serviceability and ultimate limit state) of the structural system e.g. suspended ceiling.

Materials

Mechanical properties of HKD, HKD-S, HKS-E, HKD-SR and HKD-ER

Anchor size			M6	M8	M10	M12	M16
Nominal tensile strength f_{uk}	HKD	[N/mm ²]	570	570	570	570	640
	HKD-S	[N/mm ²]	560	560	510	510	-
	HKD-E						
	HKD-SR	[N/mm ²]	540	540	540	540	-
HKD-ER							
Yield strength f_{yk}	HKD	[N/mm ²]	460	460	460	480	510
	HKD-S	[N/mm ²]	440	440	410	410	-
	HKD-E						
	HKD-SR	[N/mm ²]	355	355	355	355	-
HKD-ER							
Stressed cross-section A_s	HKD	[mm ²]	20,7	26,7	32,7	60,1	105
	HKD-S (R) HKD-E (R)	[mm ²]	20,9	26,1	28,8	58,7	-
Moment of resistance W	HKD	[mm ³]	32,3	54,6	82,9	184	431
	HKD-S (R) HKD-E (R)	[mm ³]	50	79	110	264	-
Char. bending resistance for rod or bolt $M_{Rk,s}^0$	With 5.8 Gr. Steel	[Nm]	7,6	18,7	37,4	65,5	167
	HKD-SR HKD-ER with A4-70	[Nm]	11	26	52	92	-

Material quality

Part		Material
Anchor Body	HKD	Steel Fe/Zn5 galvanised to min. 5 µm
	HKD-S HKD-E	Steel Fe/Zn5 galvanised to min. 5 µm
	HKD-SR HKD-ER	Stainless steel, 1.4401, 1.4404, 1.4571
Tapered expansion plug	HKD	Steel material
	HKD-S HKD-E	Steel material
	HKD-SR HKD-ER	Stainless steel, 1.4401, 1.4404, 1.4571

Anchor dimensions

Anchor size Anchor version			M6x25	M6x30	M8x25	M8x30	M8x40	M10x25	M10x30	M10x40	M12x25	M12x50	M16x65
Effective anchorage depth	h_{ef}	[mm]	25	30	25	30	40	25	30	40	25	50	65
Anchor diameter	d_1	[mm]	7,9	8	9,95	9,95	9,95	11,9	11,8	11,95	14,9	14,9	19,75
Plug diameter	d_2	[mm]	5,1	5	6,35	6,5	6,35	8,1	8,2	8,2	9,7	10,3	13,8
Plug length	l_1	[mm]	10	15	7	12	16	7	12	16	7,2	20	29

Anchor body

HKD

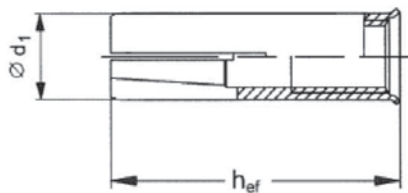

HKD-S and HKD-SR

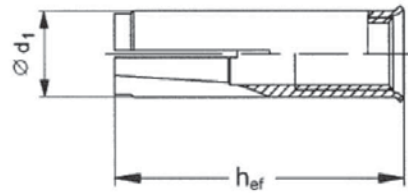

HKD-E and HKD ER

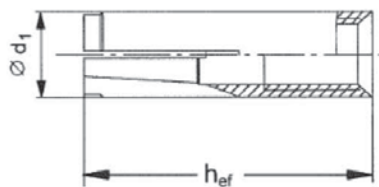

Expansions plugs

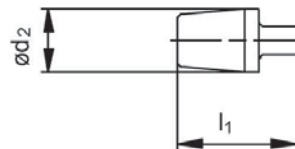
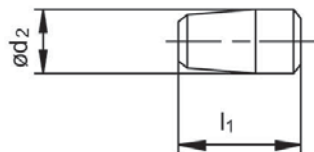

Setting

Installation equipment

Anchor size	M6x25	M6x30	M8x25	M8x30	M8x40	M10x25	M10x30	M10x40	M12x25	M12x50	M16x65
Rotary hammer	TE 2 – TE 16									TE 16 – 50	
Machine setting tool HSD-M	6x25/30	8x25/30	8x40	10x25/30	10x40	12x25	12x50	16x65			
Hand Setting tool HSD-G											
Other tools	hammer, torque wrench, blow out pump										

Setting instruction

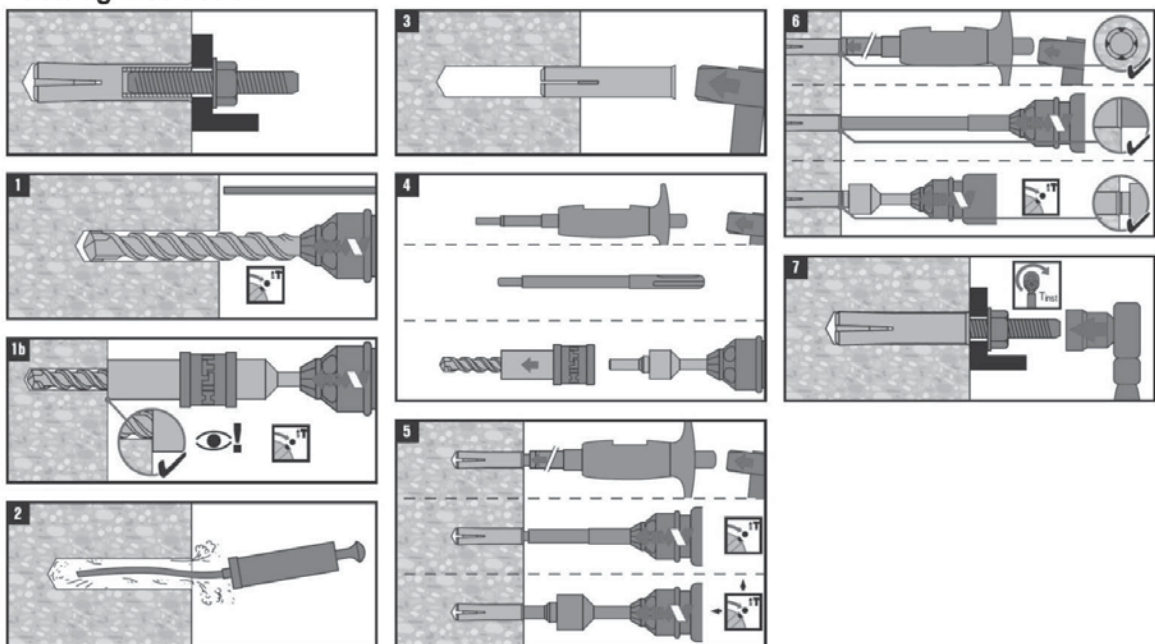

For detailed information on installation see instruction for use given with the package of the product.

Setting details: depth of drill hole h_1 and effective anchorage depth h_{ef}

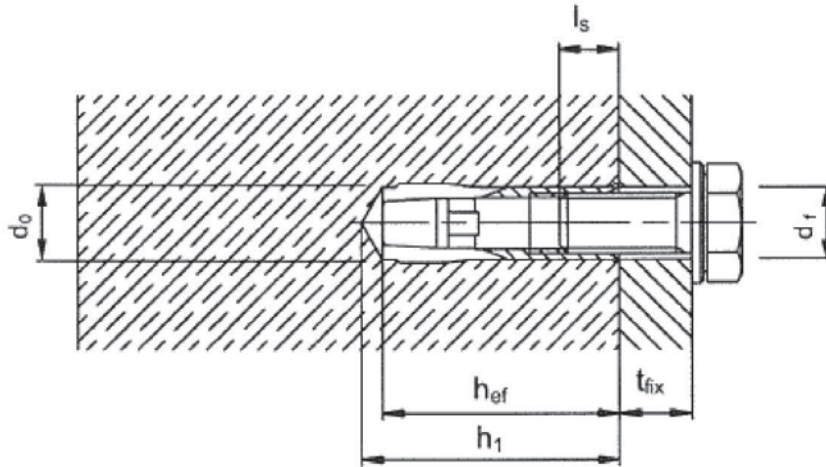

Setting details

Anchor size		M6x25	M6x30	M8x25	M8x30	M8x40	M10x25	M10x30	M10x40	M12x25	M12x50	M16x65
Nominal diameter of drill bit	d_o [mm]	8	8	10	10	10	12	12	12	15	15	20
Cutting diameter of drill bit	$d_{cut} \leq$ [mm]	8,45	8,45	10,5	10,5	10,5	12,5	12,5	12,5	15,5	15,5	20,5
Depth of drill hole	$h_1 \geq$ [mm]	27	32	27	33	43	27	33	43	27	54	70
Screwing depth	$l_{s,min}$ [mm]	6	6	8	8	8	10	10	10	12	12	16
	$l_{s,max}$ [mm]	12	12,5	11,5	14,5	17,5	12	13	18	12	22	30,5
Diameter of clearance hole in the fixture	$d_f \leq$ [mm]	7	7	9	9	9	12	12	12	14	14	18
Effective anchorage depth	h_{ef} [mm]	25	30	25	30	40	25	30	40	25	50	65
Max. torque moment	T_{inst} [Nm]	4	4	8	8	8	15	15	15	35	35	60

base material thickness, anchor spacing and edge distances

Anchor size		M6x25 M8x25 M10x25 M12x25	M6x30 M8x30 M10x30	M8x40 M10x40	M12x50	M16x65
Minimum base material thickness	h_{min} [mm]	80	80	80	-	-
Minimum spacing and Minimum edge distance HKD HKD-S (R) HKD-E (R)	s_{min} [mm]	200	200	200	-	-
	c_{min} [mm]	150	150	150	-	-
Minimum base material thickness	h_{min} [mm]	100	100	100	100	130
Minimum spacing and minimum edge distance HKD-S (R) HKD-E (R)	s_{min} [mm]	80	60	80	125	130
	c_{min} [mm]	140	105	140	175	230
Minimum spacing HKD	s_{min} [mm]	80	60	80	125	130
	for $c \geq$ [mm]	140	105	140	175	230
Minimum edge distance HKD	c_{min} [mm]	100	80	140	175	230
	for $s \geq$ [mm]	150	120	80	125	130

For spacing (edge distance) smaller than critical spacing (critical edge distance) the design loads have to be reduced.

