



Hilti HIT-HY 200 mortar with HIT-V rod

Injection mortar system		Benefits
	Hilti HIT-HY 200-A 500 ml foil pack (also available as 330 ml foil pack)	<ul style="list-style-type: none"> - SAFEset technology: drilling and borehole cleaning in one step with Hilti hollow drill bit - Suitable for non-cracked and cracked concrete C 20/25 to C 50/60 - ETA seismic approval C1 - High loading capacity, excellent handling and fast curing - Small edge distance and anchor spacing possible - Large diameter applications - Max In service temperature range up to 120°C short term/ 72°C long term - Manual cleaning for borehole diameter up to 20mm and hef ≤ 10d for non-cracked concrete only - Embedment depth range: from 60 ... 160 mm for M8 to 120 ... 600 mm for M30 - Two mortar (A and R) versions available with different curing times and same performance
	Hilti HIT-HY 200-R 500 ml foil pack (also available as 330 ml foil pack)	
	Static mixer	
	HIT-V rods HIT-V-R rods HIT-V-HCR rods	



Concrete

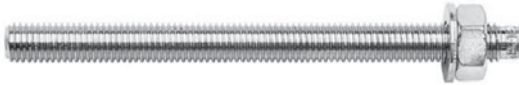

Tensile zone



Seismic
ETA-C1



Small edge distance and spacing



Variable embedment depth



Fire resistance



Approved automatic cleaning while drilling

SAFEset

Hilti SAFEset technology with hollow drill bit

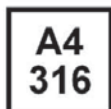

Corrosion resistance



High corrosion resistance



European Technical Approval



CE conformity



PROFIS Anchor design software

Approvals / certificates

Description	Authority / Laboratory	No. / date of issue
European technical approval ^{a)}	DIBt, Berlin	ETA-11/0493 / 2013-06-20 (Hilti HIT-HY 200-A) ETA-12/0084 / 2013-06-20 (Hilti HIT-HY 200-R)
Fire test report	IBMB, Brunswick	3501/676/13 / 2012-08-03

a) All data given in this section according ETA-11/0493 and ETA-12/0084, issue 2013-06-20.

Basic loading data (for a single anchor)

All data in this section applies to

For details see Simplified design method

- Correct setting (See setting instruction)
- No edge distance and spacing influence
- Steel failure
- Base material thickness, as specified in the table
- One typical embedment depth, as specified in the table
- One anchor material, as specified in the tables
- Concrete C 20/25, $f_{ck,cube} = 25 \text{ N/mm}^2$
- Temperature range I
(min. base material temperature -40°C , max. long term/short term base material temperature: $+24^\circ\text{C}/40^\circ\text{C}$)
- Installation temperature range -10°C to $+40^\circ\text{C}$

Embedment depth ^{a)} and base material thickness for the basic loading data. Mean ultimate resistance, characteristic resistance, design resistance, recommended loads.

Anchor size	M8	M10	M12	M16	M20	M24	M27	M30
Typical embedment depth h_{ef} [mm]	80	90	110	125	170	210	240	270
Base material thickness h [mm]	110	120	140	165	220	270	300	340

a) The allowed range of embedment depth is shown in the setting details. The corresponding load values can be calculated according to the simplified design method.

Mean ultimate resistance: concrete C 20/25 , anchor HIT-V 5.8

Anchor size	M8	M10	M12	M16	M20	M24	M27	M30
Non-cracked concrete								
Tensile $N_{Ru,m}$ HIT-V 5.8 [kN]	18,9	30,5	44,1	83,0	129,2	185,9	241,5	295,1
Shear $V_{Ru,m}$ HIT-V 5.8 [kN]	9,5	15,8	22,1	41,0	64,1	92,4	120,8	147,0
Cracked concrete								
Tensile $N_{Ru,m}$ HIT-V 5.8 [kN]	16,0	22,5	44,0	66,7	105,9	145,4	177,7	212,0
Shear $V_{Ru,m}$ HIT-V 5.8 [kN]	9,5	15,8	22,1	41,0	64,1	92,4	120,8	147,0

Characteristic resistance: concrete C 20/25 , anchor HIT-V 5.8

Anchor size	M8	M10	M12	M16	M20	M24	M27	M30
Non-cracked concrete								
Tensile N_{Rk} HIT-V 5.8 [kN]	18,0	29,0	42,0	70,6	111,9	153,7	187,8	224,0
Shear V_{Rk} HIT-V 5.8 [kN]	9,0	15,0	21,0	39,0	61,0	88,0	115,0	140,0
Cracked concrete								
Tensile N_{Rk} HIT-V 5.8 [kN]	12,1	17,0	33,2	50,3	79,8	109,6	133,9	159,7
Shear V_{Rk} HIT-V 5.8 [kN]	9,0	15,0	21,0	39,0	61,0	88,0	115,0	140,0

Design resistance: concrete C 20/25 , anchor HIT-V 5.8

Anchor size	M8	M10	M12	M16	M20	M24	M27	M30
Non-cracked concrete								
Tensile N_{Rd} HIT-V 5.8 [kN]	12,0	19,3	28,0	39,2	62,2	85,4	104,3	124,5
Shear V_{Rd} HIT-V 5.8 [kN]	7,2	12,0	16,8	31,2	48,8	70,4	92,0	112,0
Cracked concrete								
Tensile N_{Rd} HIT-V 5.8 [kN]	6,7	9,4	18,4	27,9	44,3	60,9	74,4	88,7
Shear V_{Rd} HIT-V 5.8 [kN]	7,2	12,0	16,8	31,2	48,8	70,4	92,0	112,0

Recommended loads ^{a)}: concrete C 20/25 , anchor HIT-V 5.8

Anchor size			M8	M10	M12	M16	M20	M24	M27	M30
Non-cracked concrete										
Tensile N_{rec}	HIT-V 5.8	[kN]	8,6	13,8	20,0	28,0	44,4	61,0	74,5	88,9
Shear V_{rec}	HIT-V 5.8	[kN]	5,1	8,6	12,0	22,3	34,9	50,3	65,7	80,0
Cracked concrete										
Tensile N_{rec}	HIT-V 5.8	[kN]	4,8	6,7	13,2	19,9	31,7	43,5	53,1	63,4
Shear V_{rec}	HIT-V 5.8	[kN]	5,1	8,6	12,0	22,3	34,9	50,3	65,7	80,0

a) With overall partial safety factor for action $\gamma = 1,4$. The partial safety factors for action depend on the type of loading and shall be taken from national regulations.

Service temperature range

Hilti HIT-HY 200 injection mortar may be applied in the temperature ranges given below. An elevated base material temperature may lead to a reduction of the design bond resistance.

Temperature range	Base material temperature	Maximum long term base material temperature	Maximum short term base material temperature
Temperature range I	-40 °C to +40 °C	+24 °C	+40 °C
Temperature range II	-40 °C to +80 °C	+50 °C	+80 °C
Temperature range III	-40 °C to +120 °C	+72 °C	+120 °C

Max short term base material temperature

Short-term elevated base material temperatures are those that occur over brief intervals, e.g. as a result of diurnal cycling.

Max long term base material temperature

Long-term elevated base material temperatures are roughly constant over significant periods of time.

Materials
Mechanical properties of HIT-V

Anchor size			M8	M10	M12	M16	M20	M24	M27	M30
Nominal tensile strength f_{uk}	HIT-V 5.8	[N/mm ²]	500	500	500	500	500	500	500	500
	HIT-V 8.8	[N/mm ²]	800	800	800	800	800	800	800	800
	HIT-V-R	[N/mm ²]	700	700	700	700	700	700	500	500
	HIT-V-HCR	[N/mm ²]	800	800	800	800	800	700	700	700
Yield strength f_{yk}	HIT-V 5.8	[N/mm ²]	400	400	400	400	400	400	400	400
	HIT-V 8.8	[N/mm ²]	640	640	640	640	640	640	640	640
	HIT-V -R	[N/mm ²]	450	450	450	450	450	450	210	210
	HIT-V-HCR	[N/mm ²]	640	640	640	640	640	400	400	400
Stressed cross-section A_s	HIT-V	[mm ²]	36,6	58,0	84,3	157	245	353	459	561
Moment of resistance W	HIT-V	[mm ³]	31,2	62,3	109	277	541	935	1387	1874

Material quality

Part	Material
Threaded rod HIT-V(F)	Strength class 5.8, A ₅ > 8% ductile steel galvanized ≥ 5 μm, (F) hot dipped galvanized ≥ 45 μm,
Threaded rod HIT-V(F)	Strength class 8.8, A ₅ > 8% ductile steel galvanized ≥ 5 μm, (F) hot dipped galvanized ≥ 45 μm,
Threaded rod HIT-V-R	Stainless steel grade A4, A ₅ > 8% ductile strength class 70 for ≤ M24 and class 50 for M27 to M30, 1.4401; 1.4404; 1.4578; 1.4571; 1.4439; 1.4362
Threaded rod HIT-V-HCR	High corrosion resistant steel, 1.4529; 1.4565 strength ≤ M20: R _m = 800 N/mm ² , R _{p0.2} = 640 N/mm ² , A ₅ > 8% ductile M24 to M30: R _m = 700 N/mm ² , R _{p0.2} = 400 N/mm ² , A ₅ > 8% ductile
Washer ISO 7089	Steel galvanized, hot dipped galvanized, Stainless steel, 1.4401; 1.4404; 1.4578; 1.4571; 1.4439; 1.4362 High corrosion resistant steel, 1.4529; 1.4565
Nut EN ISO 4032	Strength class 8, steel galvanized ≥ 5 μm, hot dipped galvanized ≥ 45 μm, Strength class 70, stainless steel grade A4, 1.4401; 1.4404; 1.4578; 1.4571; 1.4439; 1.4362 Strength class 70, high corrosion resistant steel, 1.4529; 1.4565

Anchor dimensions

Anchor size	M8	M10	M12	M16	M20	M24	M27	M30
Anchor rod HIT-V, HIT-V-R, HIT-V-HCR	Anchor rods HIT-V (-R / -HCR) are available in variable length							

Setting

installation equipment

Anchor size	M8	M10	M12	M16	M20	M24	M27	M30
Rotary hammer	TE 2 – TE 16				TE 40 – TE 70			
Other tools, hammer drilling	compressed air gun or blow out pump, set of cleaning brushes, dispenser							

Setting instruction

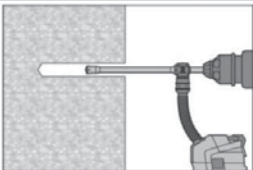
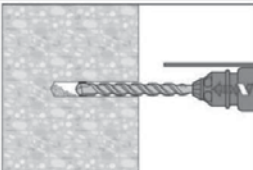
Bore hole drilling	
	Drill hole to the required embedment depth with an appropriately sized Hilti TE-CD or TE-YD hollow drill bit with Hilti vacuum attachment. This drilling method properly cleans the borehole and removes dust while drilling. After drilling is complete, proceed to the "injection preparation" step in the instructions for use.
	Drill Hole to the required embedment depth with a hammer drill set in rotation-hammer mode using an appropriately sized carbide drill bit.

Bore hole cleaning Just before setting an anchor, the bore hole must be free of dust and debris.

a) Manual Cleaning (MC) non-cracked concrete only

for bore hole diameters $d_0 \leq 20\text{mm}$ and bore hole depth $h_0 \leq 10d$

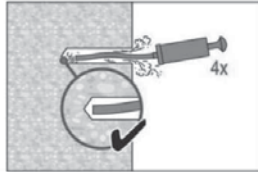

The Hilti manual pump may be used for blowing out bore holes up to diameters $d_0 \leq 20\text{ mm}$ and embedment depths up to $h_{ef} \leq 10d$.
Blow out at least 4 times from the back of the bore hole until return air stream is free of noticeable dust

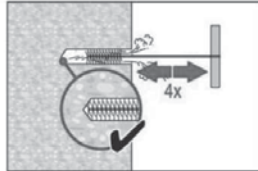

Brush 4 times with the specified brush size by inserting the steel brush Hilti HIT-RB to the back of the hole (if needed with extension) in a twisting motion and removing it.
The brush must produce natural resistance as it enters the bore hole -- if not the brush is too small and must be replaced with the proper brush diameter.

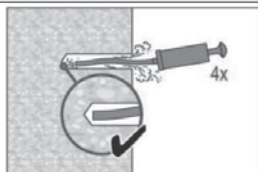

Blow out again with manual pump at least 4 times until return air stream is free of noticeable dust.

b) Compressed air cleaning (CAC)

for all bore hole diameters d_0 and all bore hole depth h_0

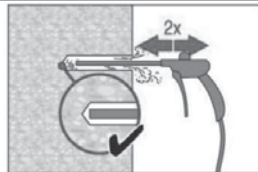

Blow 2 times from the back of the hole (if needed with nozzle extension) over the hole length with oil-free compressed air (min. 6 bar at $6\text{ m}^3/\text{h}$) until return air stream is free of noticeable dust. Bore hole diameter $\geq 32\text{ mm}$ the compressor must supply a minimum air flow of $140\text{ m}^3/\text{hour}$.

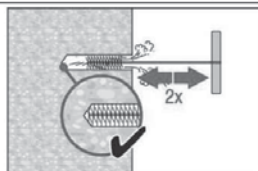

Brush 2 times with the specified brush size by inserting the steel brush Hilti HIT-RB to the back of the hole (if needed with extension) in a twisting motion and removing it.
The brush must produce natural resistance as it enters the bore hole -- if not the brush is too small and must be replaced with the proper brush diameter.



Blow again with compressed air 2 times until return air stream is free of noticeable dust.

Injection preparation

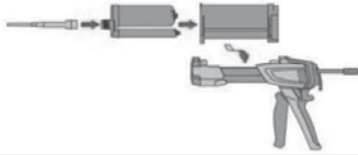

Tightly attach new Hilti mixing nozzle HIT-RE-M to foil pack manifold (snug fit). Do not modify the mixing nozzle. Observe the instruction for use of the dispenser. Check foil pack holder for proper function. Do not use damaged foil packs / holders. Swing foil pack holder with foil pack into HIT-dispenser.



Discard initial adhesive. The foil pack opens automatically as dispensing is initiated. Depending on the size of the foil pack an initial amount of adhesive has to be discarded.

Discard quantities are:

- 2 strokes for 330 ml foil pack,
- 3 strokes for 500 ml foil pack,
- 4 strokes for 500 ml foil pack $\leq 5^{\circ}\text{C}$.

Inject adhesive from the back of the borehole without forming air voids

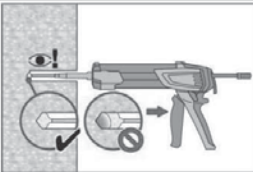

Inject the adhesive starting at the back of the hole, slowly withdrawing the mixer with each trigger pull. Fill holes approximately 2/3 full, or as required to ensure that the annular gap between the anchor and the concrete is completely filled with adhesive along the embedment length.



After injection is completed, depressurize the dispenser by pressing the release trigger. This will prevent further adhesive discharge from the mixer.

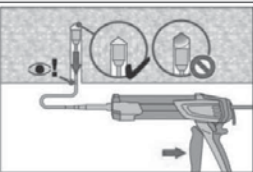

Overhead installation and/or installation with embedment depth $h_{ef} > 250\text{mm}$. For overhead installation the injection is only possible with the aid of extensions and piston plugs. Assemble HIT-RE-M mixer, extension(s) and appropriately sized piston plug. Insert piston plug to back of the hole and inject adhesive. During injection the piston plug will be naturally extruded out of the bore hole by the adhesive pressure.

Setting the element

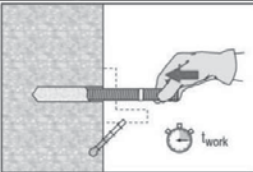

Before use, verify that the element is dry and free of oil and other contaminants.
Mark and set element to the required embedment depth until working time t_{work} has elapsed.

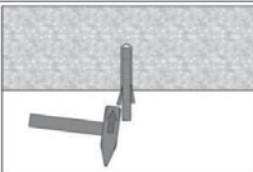

For overhead installation use piston plugs and fix embedded parts with e.g. wedges

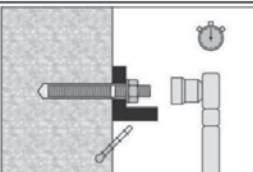

Loading the anchor:
After required curing time t_{cure} the anchor can be loaded.
The applied installation torque shall not exceed T_{max} .

For detailed information on installation see instruction for use given with the package of the product.

Working time, curing time

Temperature of the base material	Hilti HIT-HY 200-R	
	Working time in which anchor can be inserted and adjusted t_{work}	Curing time before anchor can be loaded t_{cure}
-10 °C to -5 °C	3 hour	20 hour
-4 °C to 0 °C	2 hour	8 hour
1 °C to 5 °C	1 hour	4 hour
6 °C to 10 °C	40 min	2,5 hour
11 °C to 20 °C	15 min	1,5 hour
21 °C to 30 °C	9 min	1 hour
31 °C to 40 °C	6 min	1 hour

Temperature of the base material	Hilti HIT-HY 200-A	
	Working time in which anchor can be inserted and adjusted t_{work}	Curing time before anchor can be loaded t_{cure}
-10 °C to -5 °C	1,5 hour	7 hour
-4 °C to 0 °C	50 min	4 hour
1 °C to 5 °C	25 min	2 hour
6 °C to 10 °C	15 min	75 min
11 °C to 20 °C	7 min	45 min
21 °C to 30 °C	4 min	30 min
31 °C to 40 °C	3 min	30 min

Setting details

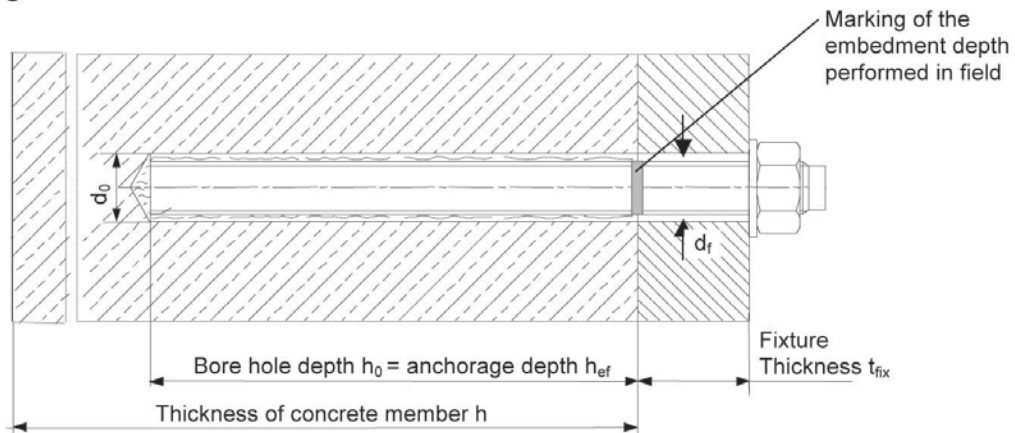

Setting details

Anchor size			M8	M10	M12	M16	M20	M24	M27	M30
Nominal diameter of drill bit	d_0	[mm]	10	12	14	18	22	28	30	35
Effective embedment and drill hole depth range ^{a)} for HIT-V	$h_{ef,min}$	[mm]	60	60	70	80	90	96	108	120
	$h_{ef,max}$	[mm]	160	200	240	320	400	480	540	600
Minimum base material thickness	h_{min}	[mm]	$h_{ef} + 30$ mm			$h_{ef} + 2 d_0$				
Diameter of clearance hole in the fixture	d_f	[mm]	9	12	14	18	22	26	30	33
Torque moment	T_{max} ^{b)}	[Nm]	10	20	40	80	150	200	270	300
Minimum spacing	s_{min}	[mm]	40	50	60	80	100	120	135	150
Minimum edge distance	c_{min}	[mm]	40	50	60	80	100	120	135	150
Critical spacing for splitting failure	$s_{cr,sp}$	[mm]	$2 c_{cr,sp}$							
Critical edge distance for splitting failure ^{c)}	$c_{cr,sp}$	[mm]	$1,0 \cdot h_{ef}$ for $h / h_{ef} \geq 2,0$							
			$4,6 h_{ef} - 1,8 h$ for $2,0 > h / h_{ef} > 1,3$							
			$2,26 h_{ef}$ for $h / h_{ef} \leq 1,3$							
Critical spacing for concrete cone failure	$s_{cr,N}$	[mm]	$2 c_{cr,N}$							
Critical edge distance for concrete cone failure ^{d)}	$c_{cr,N}$	[mm]	$1,5 h_{ef}$							

For spacing (or edge distance) smaller than critical spacing (or critical edge distance) the design loads have to be reduced.

- Embedment depth range: $h_{ef,min} \leq h_{ef} \leq h_{ef,max}$
- Maximum recommended torque moment to avoid splitting failure during installation with minimum spacing and/or edge distance.
- h : base material thickness ($h \geq h_{min}$), h_{ef} : embedment depth
- The critical edge distance for concrete cone failure depends on the embedment depth h_{ef} and the design bond resistance. The simplified formula given in this table is on the safe side.

Simplified design method

Simplified version of the design method according ETAG 001, TR 029. Design resistance according data given in ETA-11/0493 issued 2013-06-20 for HIT-HY 200-A and ETA-12/0084 issued 2013-06-20 for HIT-HY 200-R. Both mortars possess identical technical load performance.

- Influence of concrete strength
- Influence of edge distance
- Influence of spacing
- Valid for a group of two anchors. (The method may also be applied for anchor groups with more than two anchors or more than one edge distance. The influencing factors must then be considered for each edge distance and spacing. The simplified calculated design loads take a conservative approach: They will be lower than the exact values according to ETAG 001, TR 029. For an optimized design, anchor calculation can be performed using PROFIS anchor design software.

The design method is based on the following simplification:

- No different loads are acting on individual anchors (no eccentricity)

The values are valid for one anchor.

For more complex fastening applications please use the anchor design software PROFIS Anchor.

Tension loading

The design tensile resistance is the lower value of

- Steel resistance: $N_{Rd,s}$
- Combined pull-out and concrete cone resistance: $N_{Rd,p} = N_{Rd,p}^0 \cdot f_{B,p} \cdot f_{1,N} \cdot f_{2,N} \cdot f_{3,N} \cdot f_{h,p} \cdot f_{re,N}$
- Concrete cone resistance: $N_{Rd,c} = N_{Rd,c}^0 \cdot f_B \cdot f_{1,N} \cdot f_{2,N} \cdot f_{3,N} \cdot f_{h,N} \cdot f_{re,N}$
- Concrete splitting resistance (only non-cracked concrete): $N_{Rd,sp} = N_{Rd,c}^0 \cdot f_B \cdot f_{1,sp} \cdot f_{2,sp} \cdot f_{3,sp} \cdot f_{h,N} \cdot f_{re,N}$

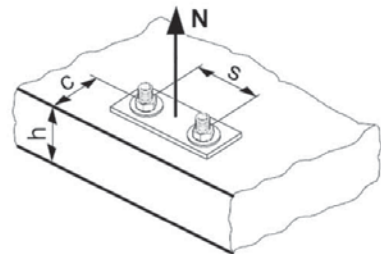

Basic design tensile resistance

Design steel resistance $N_{Rd,s}$

Anchor size		M8	M10	M12	M16	M20	M24	M27	M30
$N_{Rd,s}$	HIT-V 5.8 [kN]	12,0	19,3	28,0	52,7	82,0	118,0	153,3	187,3
	HIT-V 8.8 [kN]	19,3	30,7	44,7	84,0	130,7	188,0	244,7	299,3
	HIT-V-R [kN]	13,9	21,9	31,6	58,8	92,0	132,1	80,4	98,3
	HIT-V-HCR [kN]	19,3	30,7	44,7	84,0	130,7	117,6	152,9	187,1

Design combined pull-out and concrete cone resistance

$$N_{Rd,p} = N_{Rd,p}^0 \cdot f_{B,p} \cdot f_{1,N} \cdot f_{2,N} \cdot f_{3,N} \cdot f_{h,p} \cdot f_{re,N}$$

Anchor size	M8	M10	M12	M16	M20	M24	M27	M30
Typical embedment depth $h_{ef} = h_{ef,typ}$ [mm]	80	90	110	125	170	210	240	270
Non-cracked concrete								
$N_{Rd,p}^0$ Temperature range I [kN]	22,3	31,4	46,1	69,8	118,7	175,9	169,6	212,1
$N_{Rd,p}^0$ Temperature range II [kN]	19,0	26,7	39,2	59,3	100,9	149,5	135,7	169,6
$N_{Rd,p}^0$ Temperature range III [kN]	15,6	22,0	32,3	48,9	83,1	123,2	124,4	155,5
Cracked concrete								
$N_{Rd,p}^0$ Temperature range I [kN]	6,7	9,4	18,4	27,9	47,5	70,4	90,5	113,1
$N_{Rd,p}^0$ Temperature range II [kN]	5,0	7,1	15,0	22,7	38,6	57,2	73,5	91,9
$N_{Rd,p}^0$ Temperature range III [kN]	4,5	6,3	12,7	19,2	32,6	48,4	62,2	77,8

$$\text{Design concrete cone resistance } N_{Rd,c} = N_{Rd,c}^0 \cdot f_B \cdot f_{1,N} \cdot f_{2,N} \cdot f_{3,N} \cdot f_{h,N} \cdot f_{re,N}$$

$$\text{Design splitting resistance } N_{Rd,sp} = N_{Rd,c}^0 \cdot f_B \cdot f_{1,sp} \cdot f_{2,sp} \cdot f_{3,sp} \cdot f_{h,N} \cdot f_{re,N}$$

Anchor size	M8	M10	M12	M16	M20	M24	M27	M30
$N_{Rd,c}^0$ Non-cracked concrete [kN]	20,1	24,0	32,4	39,2	62,2	85,4	104,3	124,5
$N_{Rd,c}^0$ Cracked concrete [kN]	14,3	17,1	23,1	28,0	44,3	60,9	74,4	88,7

a) Splitting resistance must only be considered for non-cracked concrete.

Influencing factors

Influence of concrete strength on combined pull-out and concrete cone resistance

Concrete strength designation (ENV 206)	C 20/25	C 25/30	C 30/37	C 35/45	C 40/50	C 45/55	C 50/60
$f_{B,p} =$	1,00	1,00	1,00	1,00	1,00	1,00	1,00

Influence of embedment depth on combined pull-out and concrete cone resistance

$$f_{h,p} = h_{ef}/h_{ef,typ}$$

Influence of concrete strength on concrete cone resistance

Concrete strength designation (ENV 206)	C 20/25	C 25/30	C 30/37	C 35/45	C 40/50	C 45/55	C 50/60
$f_B = (f_{ck,cube}/25\text{N/mm}^2)^{0,5 \text{ a)}$	1	1,1	1,22	1,34	1,41	1,48	1,55

a) $f_{ck,cube}$ = concrete compressive strength, measured on cubes with 150 mm side length

Influence of edge distance ^{a)}

$c/c_{cr,N}$	0,1	0,2	0,3	0,4	0,5	0,6	0,7	0,8	0,9	1
$c/c_{cr,sp}$										
$f_{1,N} = 0,7 + 0,3 \cdot c/c_{cr,N} \leq 1$	0,73	0,76	0,79	0,82	0,85	0,88	0,91	0,94	0,97	1
$f_{1,sp} = 0,7 + 0,3 \cdot c/c_{cr,sp} \leq 1$										
$f_{2,N} = 0,5 \cdot (1 + c/c_{cr,N}) \leq 1$	0,55	0,60	0,65	0,70	0,75	0,80	0,85	0,90	0,95	1
$f_{2,sp} = 0,5 \cdot (1 + c/c_{cr,sp}) \leq 1$										

a) The edge distance shall not be smaller than the minimum edge distance c_{min} . These influencing factors must be considered for every edge distance smaller than the critical edge distance.

Influence of anchor spacing ^{a)}

$s/s_{cr,N}$	0,1	0,2	0,3	0,4	0,5	0,6	0,7	0,8	0,9	1
$s/s_{cr,sp}$										
$f_{3,N} = 0,5 \cdot (1 + s/s_{cr,N}) \leq 1$	0,55	0,60	0,65	0,70	0,75	0,80	0,85	0,90	0,95	1
$f_{3,sp} = 0,5 \cdot (1 + s/s_{cr,sp}) \leq 1$										

a) The anchor spacing shall not be smaller than the minimum anchor spacing s_{min} . This influencing factor must be considered for every anchor spacing.

Influence of embedment depth on concrete cone resistance

$$f_{h,N} = (h_{ef}/h_{ef,typ})^{1,5}$$

Influence of reinforcement

h_{ef} [mm]	60	70	80	90	≥ 100
$f_{re,N} = 0,5 + h_{ef}/200mm \leq 1$	0,8 ^{a)}	0,85 ^{a)}	0,9 ^{a)}	0,95 ^{a)}	1

a) This factor applies only for dense reinforcement. If in the area of anchorage there is reinforcement with a spacing ≥ 150 mm (any diameter) or with a diameter ≤ 10 mm and a spacing ≥ 100 mm, then a factor $f_{re,N} = 1$ may be applied.

Shear loading

The design shear resistance is the lower value of

- Steel resistance: $V_{Rd,s}$
- Concrete pryout resistance: $V_{Rd,cp} = k \cdot \text{lower value of } N_{Rd,p} \text{ and } N_{Rd,c}$
- Concrete edge resistance: $V_{Rd,c} = V_{Rd,c}^0 \cdot f_B \cdot f_h \cdot f_4 \cdot f_{hef} \cdot f_c$

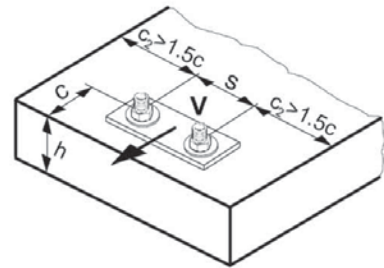

Basic design shear resistance

Design steel resistance $V_{Rd,s}$

Anchor size		M8	M10	M12	M16	M20	M24	M27	M30
$V_{Rd,s}$	HIT-V 5.8	[kN]	7,2	12,0	16,8	31,2	48,8	70,4	112,0
	HIT-V 8.8	[kN]	12,0	18,4	27,2	50,4	78,4	112,8	179,2
	HIT-V-R	[kN]	8,3	12,8	19,2	35,3	55,1	79,5	58,8
	HIT-V-HCR	[kN]	12,0	18,4	27,2	50,4	78,4	70,9	92,0

Design concrete pryout resistance $V_{Rd,cp} = \text{lower value}^a)$ of $k \cdot N_{Rd,p}$ and $k \cdot N_{Rd,c}$

$$k = 2$$

a) $N_{Rd,p}$: Design combined pull-out and concrete cone resistance, $N_{Rd,c}$: Design concrete cone resistance

Design concrete edge resistance $V_{Rd,c} = V_{Rd,c}^0 \cdot f_B \cdot f_h \cdot f_4 \cdot f_{hef} \cdot f_c$

Anchor size		M8	M10	M12	M16	M20	M24	M27	M30
Non-cracked concrete									
$V_{Rd,c}^0$	[kN]	5,9	8,6	11,6	18,7	27,0	36,6	44,5	53,0
Cracked concrete									
$V_{Rd,c}^0$	[kN]	4,2	6,1	8,2	13,2	19,2	25,9	31,5	37,5

Influencing factors

Influence of concrete strength

Concrete strength designation (ENV 206)	C 20/25	C 25/30	C 30/37	C 35/45	C 40/50	C 45/55	C 50/60
$f_B = (f_{ck,cube}/25N/mm^2)^{1/2}$ a)	1	1,1	1,22	1,34	1,41	1,48	1,55

a) $f_{ck,cube}$ = concrete compressive strength, measured on cubes with 150 mm side length

Influence of angle between load applied and the direction perpendicular to the free edge

Angle β	0°	10°	20°	30°	40°	50°	60°	70°	80°	≥ 90°
$f_{\beta} = \frac{1}{\sqrt{(\cos \alpha_r)^2 + \left(\frac{\sin \alpha_r}{2,5}\right)^2}}$	1	1,01	1,05	1,13	1,24	1,40	1,64	1,97	2,32	2,50

Influence of base material thickness

h/c	0,15	0,3	0,45	0,6	0,75	0,9	1,05	1,2	1,35	≥ 1,5
$f_h = \{h/(1,5 \cdot c)\}^{1/2} \leq 1$	0,32	0,45	0,55	0,63	0,71	0,77	0,84	0,89	0,95	1,00

Influence of anchor spacing and edge distance ^{a)} for concrete edge resistance: f_4

$$f_4 = (c/h_{ef})^{1,5} \cdot (1 + s / [3 \cdot c]) \cdot 0,5$$

c/h _{ef}	Single anchor	Group of two anchors s/h _{ef}															
		0,75	1,50	2,25	3,00	3,75	4,50	5,25	6,00	6,75	7,50	8,25	9,00	9,75	10,50	11,25	
0,50	0,35	0,27	0,35	0,35	0,35	0,35	0,35	0,35	0,35	0,35	0,35	0,35	0,35	0,35	0,35	0,35	0,35
0,75	0,65	0,43	0,54	0,65	0,65	0,65	0,65	0,65	0,65	0,65	0,65	0,65	0,65	0,65	0,65	0,65	0,65
1,00	1,00	0,63	0,75	0,88	1,00	1,00	1,00	1,00	1,00	1,00	1,00	1,00	1,00	1,00	1,00	1,00	1,00
1,25	1,40	0,84	0,98	1,12	1,26	1,40	1,40	1,40	1,40	1,40	1,40	1,40	1,40	1,40	1,40	1,40	1,40
1,50	1,84	1,07	1,22	1,38	1,53	1,68	1,84	1,84	1,84	1,84	1,84	1,84	1,84	1,84	1,84	1,84	1,84
1,75	2,32	1,32	1,49	1,65	1,82	1,98	2,15	2,32	2,32	2,32	2,32	2,32	2,32	2,32	2,32	2,32	2,32
2,00	2,83	1,59	1,77	1,94	2,12	2,30	2,47	2,65	2,83	2,83	2,83	2,83	2,83	2,83	2,83	2,83	2,83
2,25	3,38	1,88	2,06	2,25	2,44	2,63	2,81	3,00	3,19	3,38	3,38	3,38	3,38	3,38	3,38	3,38	3,38
2,50	3,95	2,17	2,37	2,57	2,77	2,96	3,16	3,36	3,56	3,76	3,95	3,95	3,95	3,95	3,95	3,95	3,95
2,75	4,56	2,49	2,69	2,90	3,11	3,32	3,52	3,73	3,94	4,15	4,35	4,56	4,56	4,56	4,56	4,56	4,56
3,00	5,20	2,81	3,03	3,25	3,46	3,68	3,90	4,11	4,33	4,55	4,76	4,98	5,20	5,20	5,20	5,20	5,20
3,25	5,86	3,15	3,38	3,61	3,83	4,06	4,28	4,51	4,73	4,96	5,18	5,41	5,63	5,86	5,86	5,86	5,86
3,50	6,55	3,51	3,74	3,98	4,21	4,44	4,68	4,91	5,14	5,38	5,61	5,85	6,08	6,31	6,55	6,55	6,55
3,75	7,26	3,87	4,12	4,36	4,60	4,84	5,08	5,33	5,57	5,81	6,05	6,29	6,54	6,78	7,02	7,26	7,26
4,00	8,00	4,25	4,50	4,75	5,00	5,25	5,50	5,75	6,00	6,25	6,50	6,75	7,00	7,25	7,50	7,75	7,75
4,25	8,76	4,64	4,90	5,15	5,41	5,67	5,93	6,18	6,44	6,70	6,96	7,22	7,47	7,73	7,99	8,25	8,25
4,50	9,55	5,04	5,30	5,57	5,83	6,10	6,36	6,63	6,89	7,16	7,42	7,69	7,95	8,22	8,49	8,75	8,75
4,75	10,35	5,45	5,72	5,99	6,27	6,54	6,81	7,08	7,36	7,63	7,90	8,17	8,45	8,72	8,99	9,26	9,26
5,00	11,18	5,87	6,15	6,43	6,71	6,99	7,27	7,55	7,83	8,11	8,39	8,66	8,94	9,22	9,50	9,78	9,78
5,25	12,03	6,30	6,59	6,87	7,16	7,45	7,73	8,02	8,31	8,59	8,88	9,17	9,45	9,74	10,02	10,31	10,31
5,50	12,90	6,74	7,04	7,33	7,62	7,92	8,21	8,50	8,79	9,09	9,38	9,67	9,97	10,26	10,55	10,85	10,85

a) The anchor spacing and the edge distance shall not be smaller than the minimum anchor spacing s_{min} and the minimum edge distance c_{min} .

Influence of embedment depth

h_{ef}/d	4	4,5	5	6	7	8	9	10	11
$f_{hef} = 0,05 \cdot (h_{ef} / d)^{1,68}$	0,51	0,63	0,75	1,01	1,31	1,64	2,00	2,39	2,81
h_{ef}/d	12	13	14	15	16	17	18	19	20
$f_{hef} = 0,05 \cdot (h_{ef} / d)^{1,68}$	3,25	3,72	4,21	4,73	5,27	5,84	6,42	7,04	7,67

Influence of edge distance ^{a)}

c/d	4	6	8	10	15	20	30	40
$f_c = (d / c)^{0,19}$	0,77	0,71	0,67	0,65	0,60	0,57	0,52	0,50

a) The edge distance shall not be smaller than the minimum edge distance c_{min} .

Combined tension and shear loading

For combined tension and shear loading see section "Anchor Design".

Seismic design C1

Basic loading data for concrete C20/25 – C50/60

All data in this section applies to:

- Seismic design according to TR045

The following technical data are based on: ETA-11/0493 and ETA-12/0084, issue 2013-06-20

Anchorage depth range

Anchor size		M8	M10	M12	M16	M20	M24	M27	M30
Effective anchorage	$h_{ef,min}$ [mm]	60	60	70	80	90	96	108	120
depth range	$h_{ef,max}$ [mm]	160	200	240	320	400	480	540	600

Tension resistance in case of seismic performance category C1

Anchor size		M8	M10	M12	M16	M20	M24	M27	M30
Characteristic tension resistance to steel failure									
HIT-V-5.8(F)	$N_{RK,s,seis}$ [kN]	-	29	42	79	123	177	230	281
HIT-V-8.8(F)	$N_{RK,s,seis}$ [kN]	-	46	67	126	196	282	367	449
Partial safety factor	$\gamma_{Ms,seis}$ [-]	1,5							
HIT-V-R	$N_{RK,s,seis}$ [kN]	-	41	59	110	172	247	230	281
Partial safety factor	$\gamma_{Ms,seis}$ [-]	1,87						2,86	
HIT-V-HCR	$N_{RK,s,seis}$ [kN]	-	46	67	126	196	247	321	393
Partial safety factor	$\gamma_{Ms,seis}$ [-]	1,5					2,1		
Characteristic bond resistance in cracked concrete C20/25 to C50/60									
Temperature range I: 40°C/24°C	$\tau_{RK,seis}$ [N/mm ²]	-	5,2				7,0		
Temperature range II: 80°C/50°C	$\tau_{RK,seis}$ [N/mm ²]	-	3,9				5,7		
Temperature range III: 120°C/72°C	$\tau_{RK,seis}$ [N/mm ²]	-	3,5				4,8		

Partial safety factor	$\gamma_{Mp,seis}$	[-]	1,8
Concrete cone resistance and splitting resistance			
Partial safety factor	$\gamma_{Mc,seis} = \gamma_{Msp,seis}$	[-]	1,8

Displacement under tension load in case of seismic performance category C1 ¹⁾

Anchor size	M8	M10	M12	M16	M20	M24	M27	M30
Displacement ¹⁾	$\delta_{N,seis}$	[mm]	-	0,8	0,8	0,8	0,8	0,8

1) Maximum displacement during cycling (seismic event).

Shear resistance in case of seismic performance category C1

Anchor size	M8	M10	M12	M16	M20	M24	M27	M30		
Characteristic shear resistance to steel failure										
for HIT-V-5.8(F)	$V_{Rk,s,seis}$	[kN]	-	11	15	27	43	62	81	98
for HIT-V-8.8(F)	$V_{Rk,s,seis}$	[kN]	-	16	24	44	69	99	129	157
Partial safety factor	$\gamma_{Ms,seis}$	[-]	1,25							
for HIT-V-R	$V_{Rk,s,seis}$	[kN]	-	14	21	39	60	87	81	98
Partial safety factor	$\gamma_{Ms,seis}$	[-]	1,56					2,38		
for HIT-V-HCR	$V_{Rk,s,seis}$	[kN]	-	16	24	44	69	87	113	137
Partial safety factor	$\gamma_{Ms,seis}$	[-]	1,25				1,75			
Concrete pryout resistance and concrete edge resistance										
Partial safety factor	$\gamma_{Mcp,seis} = \gamma_{Mc,seis}$	[-]	1,5							

Displacement under shear load in case of seismic performance category C1 ¹⁾

Anchor size	M8	M10	M12	M16	M20	M24	M27	M30		
Displacement ¹⁾	$\delta_{V,seis}$	[mm]	-	3,5	3,8	4,4	5,0	5,6	6,1	6,5

1) Maximum displacement during cycling (seismic event).

For seismic resistant fastening applications please use the anchor design software PROFIS Anchor.